

MY bernette EMBROIDERY

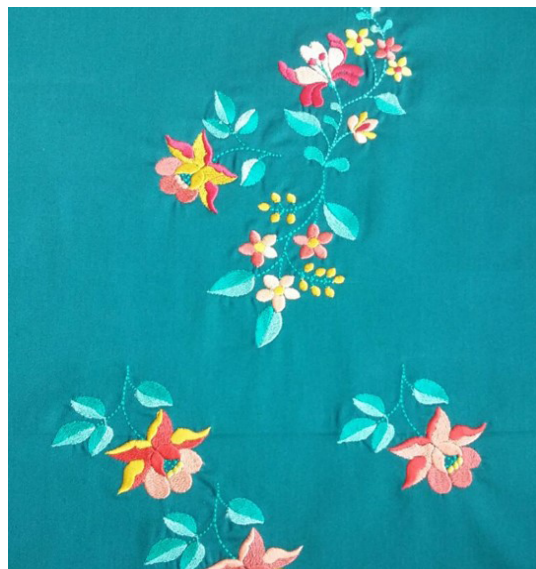

**MASTERY
BOOK
SERIES**



bernette EMBROIDERY WORKBOOK
For b79 and b70 DECO EMBROIDERY MACHINES



bernette EMBROIDERY MACHINE WORKBOOK

Table of Contents

Table of Contents	2	Centering a Combined Design In the Hoop ..	17
Introduction.....	3	Check Motif Size.....	17
Setting Up - Machine/Module	4	Placement: Absolute Check	18
Setting Up - Machine	5	Change Thread Color	19
Setting Up - Hooping Fabric and Stabilizer ..	6	Change Thread Brand	19
Setting up - Attaching the Hoop.....	7	Changing To Single Color Embroidery..	20
Design Library.....	8	Adding a Basting Box.....	20
Design Selection	8	Stitching a Design	21
Presser Foot Sole Display	9	Sequence Control	22
Stitch Plate Selection.....	9	Changing Lettering Size	23
Hoop Selection/Display Menu	10	Word Art - Changing Lettering Spacing	23
Hoop Calibration.....	11	Word Art	24
Thread Away	11	Saving and Deleting Designs	25
Editing Designs.....	12	Alter Stitch Density-Lettering.....	26
Set Up For Editing and Stitching.....	13	Reference - Embroidery Needles.....	27
Editing - Rotate/Resize.....	14	Reference - Embroidery Threads.....	28
Editing - Mirror Image	15	Reference - Stabilizers.....	29
Editing - Move Motif.....	15	Reference - Cleaning And Oiling.....	30
Editing - Adding/Deleting Designs.....	16	b79 and b70 DECO Embroidery Functions..	31

Introduction

Welcome! Learning to use your new embroidery machine to its fullest capabilities will let you enjoy your machine for many years to come.

This workbook is designed to be used as a step-by-step guide to acquaint you with the basic operation of your bernette embroidery machine. Your machine manual is an invaluable source of information also.

In addition, you will learn about needles, threads, stabilizers, embroidery hoops and accessories, all of which will increase your knowledge of embroidery and assist you in achieving success in all of your embroidery endeavors.

Once you have completed the exercises designated for your bernette machine, keep this workbook as a reference guide as you use your machine and explore the creative possibilities it affords.

Completing the class is just the first step. Using the information on a regular basis will help make it become part of your embroidery success.

Instructional video tutorials for these models are available on mybernette.com. You will also find inspiring projects and machine information on the bernette website.

b79 Embroidery and Sewing Machine



b70 DECO Embroidery Only Machine



www.mybernette.com



www.mybernette.com/b79



www.mybernette.com/b70

The information in this workbook applies to the bernette Embroidery Machine models shown above.

Note: Some exercises apply only to certain models equipped with the feature being highlighted.

Setting Up - Machine/Module

Attaching the Module:

- The slide-on table (b79) must be removed.
- Make sure there is enough space around the machine and embroidery module to allow the unimpeded movement of the embroidery arm.
- Place the machine on a flat surface (such as a table or counter top) sturdy enough to support the weight of the machine without sagging.
- Carefully slide module from left to right into the embroidery module connection (1) of the machine.



Removing the Module:

- Hold the embroidery module and press the release button (2) and pull away from the machine to remove the module.
- ALWAYS disconnect before adjusting placement on the table or when transporting.



Setting Up - Machine

STITCH PLATE

b79: Follow the manual's instructions to attach the Straight/CutWork Stitch Plate to the machine. This plate will reduce flagging of fabric, resulting in improved stitching. NOTE: The machine will recognize the plate attached.

LOWERED FEED DOG

The feed dog will automatically be lowered when the module is attached.

ATTACHING THE EMBROIDERY PRESSER FOOT - See Page 9 for information about the two embroidery presser feet available for the b79 and b70.

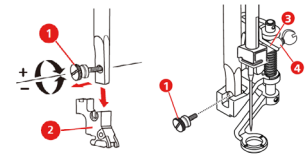

- Raise the needle and the presser foot.
- Switch the machine off and disconnect it from the power source.
- Remove the presser foot holder (2) by unscrewing the presser foot bar attaching screw (1) (b79 only).
- Attach the Embroidery Foot (JX) making sure that the spring (3) is above the needle fixing screw (4). Tighten the screw.

THREAD THE NEEDLE

1. Use the proper needle for the thread and fabric being used; insert a new needle for each project. The most commonly used thread is a 40 wt. polyester embroidery thread. Refer to Page 27, Reference-Embroidery Needles for additional information on needles, and to Page 28, Reference - Embroidery Threads.
2. Always thread with the presser foot up. This releases tension and seats the thread into the tension disks.

Threading Tips for models with both a horizontal and vertical spool pin:

- Use the horizontal spool pin with cross-wound threads; match spool cap size to end of spool.
- Use the vertical spool pin with stacked threads and for some decorative threads (metallic threads); use the foam disc under the spool to avoid extra tension on the thread.

THREAD THE BOBBIN FOR EMBROIDERY

1. Wind bobbin with 60 wt. bobbin thread. Refer to Page 28, Reference-Embroidery Threads for additional information on bobbin threads.
2. Open the bobbin cover by pushing the release button to the right. (Diagram 1)
3. Insert the bobbin so that the thread runs counterclockwise. (Diagram 2)
4. Pull the thread into the slit. (Diagram 3 - See 1)
5. Stabilize the bobbin by gently holding it in place.
6. Follow the arrow markings to bring the thread into the bobbin thread guide. (Diagram 4)
7. To cut the excess thread, take the thread end and pull it over the thread cutter. (Diagram 5 - See 2)
8. Close the bobbin cover.

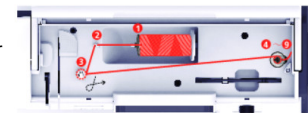

1 Spool discs 2 Thread guide
3 Thread pretension 4 Thread spool pin

Diagram 1

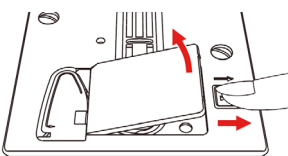

Diagram 2

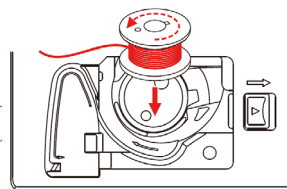

Diagram 3

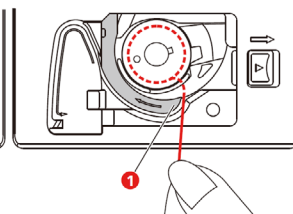

Diagram 4

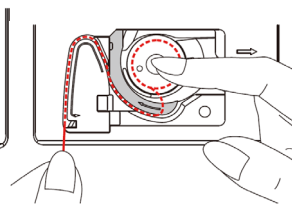
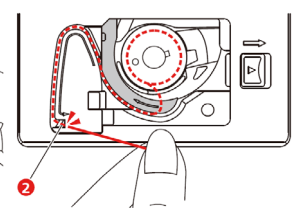
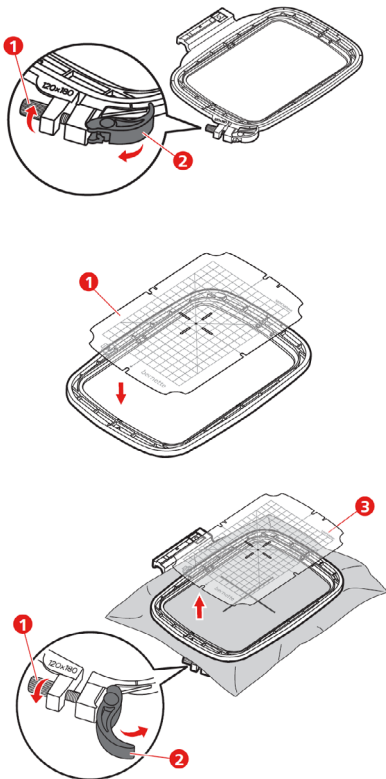

Diagram 5



Setting Up - Hooping Fabric and Stabilizer



The quick release device (2) is for changing the same type (thickness) of fabric easily and quickly.

Use the screw when adjusting for new fabrics.

Hooping Tip - Temporary Adhesive Spray:

For easier hooping of the layers, adhere the stabilizer to the fabric using a temporary spray adhesive.

- Great for basting or holding layers of fabric and/or batting together.
- Can be used as a repositionable spray, allowing items to stay sticky but be repositioned on other surfaces.
- Works well for securing "hard-to-hoop" items such as collars and cuffs to hooped stabilizer for embroidering.



Note: For best results, spray the stabilizer not the fabric.

HOOP FABRIC AND STABILIZER

1. To complete the workbook exercises, hoop fabric and stabilizer together. Find the center of a 10" x 14" piece of fabric; mark the center horizontal and vertical axis.
2. Loosen the screw (1) or open the quick release device (2) on the outer ring of the hoop. NOTE: When a new type of fabric is used, the pressure must be adjusted by turning the screw.
3. Remove the inner ring.
4. Place the template (1) in the inner ring so the bernette logo is at the front edge. Make sure the cut outs click into place.
5. Secure stabilizer to the back of the fabric by lightly spraying stabilizer with temporary adhesive spray. (See Hooping Tip below.)
6. Place fabric and stabilizer on a flat surface.
7. Position inner ring of the hoop over fabric/stabilizer, aligning horizontal and vertical center lines of the hoop with those marked on the fabric.
8. Grasping both inner hoop ring and fabric/stabilizer, lift and insert them into the outer ring of the hoop, making sure that the arrows at the bottom edges of the inner and outer rings line up with each other.
9. Close the quick release device (2). If using a new type of fabric, tighten the screw instead.
 - Hooped fabric should be taut, but not stretched or distorted.
10. The inner ring should protrude about 2 mm on the underside; this prevents the hoop from rubbing against the stitch plate.
11. Remove the plastic template (3) before stitching.

Sew HOW

Do you know:

- How to properly hoop for embroidery?
- Why a temporary adhesive spray is beneficial to the hooping process?

Setting up - Attaching the Hoop

Attaching bernette Hoops

1. Raise the needle and the embroidery foot.
2. Position the embroidery hoop underneath the embroidery foot. The needle should be in the highest position when attaching the hoop to prevent snagging fabric and/or bending the needle.
3. Push the embroidery hoop into the embroidery module until it clicks into place. The hoop is attached.

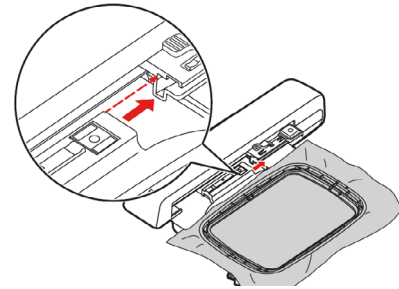

Removing bernette Hoops

1. To remove the hoop, press the securing lever (1) and pull the hoop backwards (towards yourself).

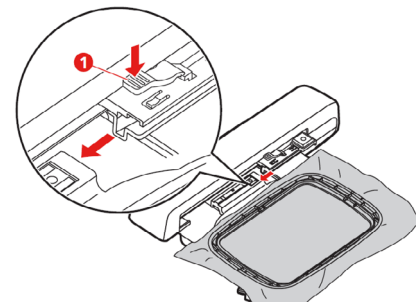

b79 and b70 DECO

Standard Embroidery Hoops: Small, Medium, Large

Notes:

All hoops come with a template for centering designs on projects.

Thanks to the new closure system, hooping is easy and practical.

The attached embroidery hoop is automatically detected by the embroidery module.

If a hoop is attached that is too small for the selected motif, a message appears.



Small Hoop
50mm x 70mm
(App. 2" x 3")



Medium Hoop
120mm x 180mm
(App. 5" x 7")



Large Hoop
160mm x 260mm
(App. 6" x 10")

Design Library

Both the bernette 79 combo machine and the bernette 70 DECO embroidery machine come with alphabets and built-in designs. These machines are also able to access designs that are stored on a USB Stick. The b79 and b70 DECO have a folder to store your personally saved designs.

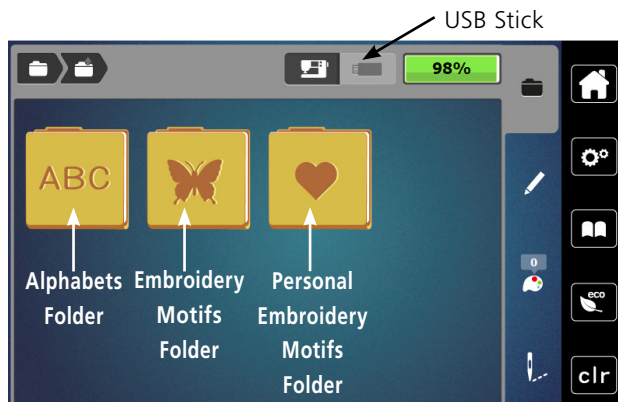
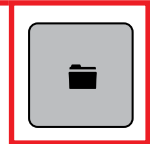

1. The picture at the left show the default folders. The folders that can be accessed are:
 - Alphabets Folder
 - Embroidery Motifs Folder (built-in designs)
 - Personal Embroidery Motifs Folder (personally saved motifs)
2. If in the embroidery Edit screen, touch the Selection (folder) icon; then touch the New Motif icon.
 -
3. Spend a few minutes looking through the design folders on your machine.

Design Formats

Note: The b79 and b70 DECO read multiple design formats. The native format is the BERNINA exp format. Besides the actual exp embroidery file, the BERNINA exp format also includes a .BMP file, a preview of the embroidery motif, and an .INF file which provides the color information. If the .INF file is missing, the motif may not displayed the real color, but only in standard colors. In that case, simply follow the thread chart that is provided with most designs, or enter the colors manually in the color overview of the motif on the machine. See your machine's manual for more information.

The following embroidery formats can also be read by the machine: VP3, VIP, PEC, HUS, DST, EXP, JEF, PES

Design Selection

Use your fingertip or the stylus that came with the machine to access buttons on the screen. Learn to use the breadcrumb path in embroidery to move between embroidery menus easier & faster.

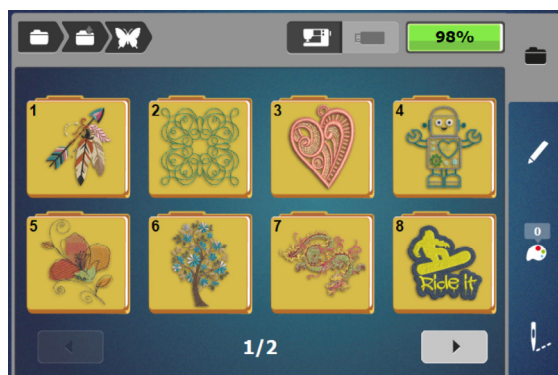

1. Select the Embroidery Motifs (butterfly) folder.
2. Select a folder of your choice.
3. To navigate back a folder, touch the Embroidery Motifs (butterfly) icon in the breadcrumb path.
4. Select Folder 1, Design 8. The design will open.
5. Proceed to next page.

Using Breadcrumbs

Notice the breadcrumb path at the top of the screen. The dots indicate the folder you are in. Touch any of the icons in the path to move to that menu.

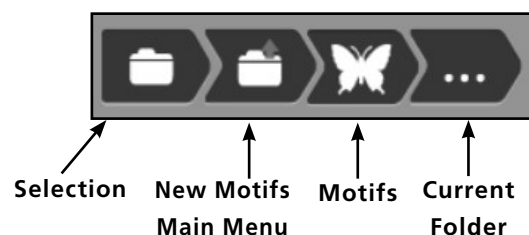

Presser Foot Sole Display

When embroidering, the machine will show a recommended presser foot sole in the Presser Foot Display.



1. The recommended presser foot sole is displayed in the Presser Foot Display.
 2. Touch the Presser Foot Display icon.
 3. The suggested sole (JX in this case) will be displayed with a green check.
- Note: In embroidery mode, you must select the foot that is actually attached to the machine as this has an influence on the presser foot height.
4. Other presser feet that are suitable are marked in the list with a star.
 5. Touch the sole on the screen to access additional helpful information (b79 only).
 6. Proceed to next section.

NOTE: There are two presser feet for embroidery.

- Embroidery foot JL works for most projects and is recommended for CutWork designs.
- Embroidery foot JX is perfect for bulky or fluffy fabrics, Puffy Lettering and multilayer quilts. Thanks to the spring mechanism, the optimum pressure is applied to the embroidered material, while at the same time, the movement of the foot compensates for any uneven areas.

Stitch Plate Selection

It is recommended that you always use a Straight Stitch Plate when embroidering. The machine recognizes what stitch plate is attached.

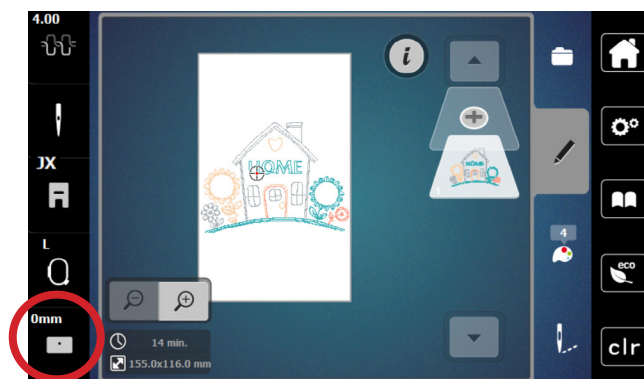

1. Attach the Straight Stitch Plate to the machine. (b79)
2. The Stitch Plate icon will display 0mm above it. NOTE: If you have the 7 mm Stitch Plate attached on the b79, you will see 7 mm displayed, and you will need to change the stitch plate for embroidery.
3. Proceed to the next page.

Hoop Selection/Display Menu

For best embroidery results, you should embroider a design in the hoop that is closest in size to the design. Embroidery designs will automatically open in the hoop that is closest to the size of the design unless an embroidery hoop is already attached to the machine. However, it is easy to change the hoop to a different hoop.

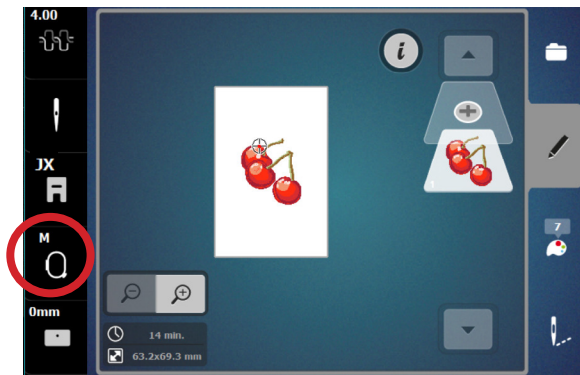
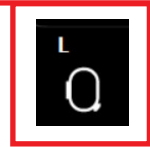

1. Open Folder 5, Design 17.
2. When a design is opened, the suggested hoop (S, M, or L) is shown above the Hoop Selection icon in white. (If a hoop is already attached to the machine, the name of the hoop attached will be indicated.)
3. Touch the Hoop Selection icon. (The Hoop Selection icon replaces the Presser Foot Pressure icon found in the sewing side of the b79.)
4. Select the Large Hoop. "L" now appears above the Hoop Selection icon in white.

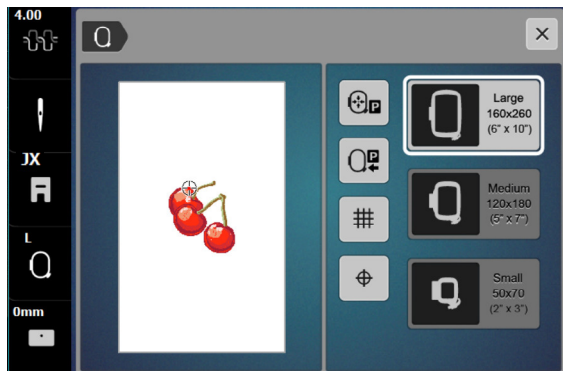

First Stitch/Design Center

1. Notice on the screen at the top of the upper cherry, the bullseye on the screen indicates the first stitch of the design.
 - Touch the Motif Center icon and the bullseye will indicate the center of the design. The Motif Center icon now has a yellow outline.
 - Touch the Motif Center icon again and the bullseye will return to the first stitch of the design.
 - For this exercise, leave the bullseye at the First Stitch.

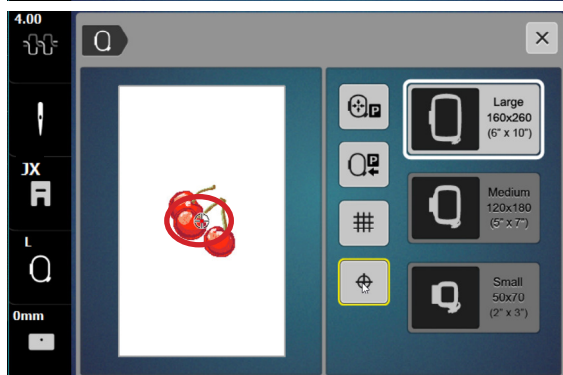

Grid Off/On

1. Touch the Grid on/off icon once. A green cross appears on the screen denoting the center of the design.
2. Touch the Grid icon a second time. A grid will appear. The grids are the same size as the grids on the hoop's plastic template and are helpful for positioning.
3. Touch the Grid on/off icon a third time and the design will have neither the grid or the center green cross indicator. Whichever mode you are in when you close the screen, will be the mode that appears on the editing screen. For today's exercise, leave the Grid in the off position.
4. Close the Hoop Selection screen.

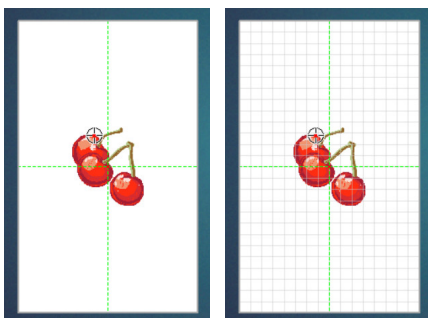

Hoop Calibration

The Large, Medium and Small Hoops must be calibrated when they are new to the machine, and also after every update. The calibration can be done with any of the three hoops, but it needs only be done with one. You will only see the visual for the Medium Hoop regardless of the hoop being calibrated.



Calibration is essential because the variance of the basting box when selected to around the hoop perimeter is only a couple millimeters away from the edge of the hoop.

For the most accuracy in calibration, have fabric hooped (with fabric and stabilizer) when calibrating a hoop.

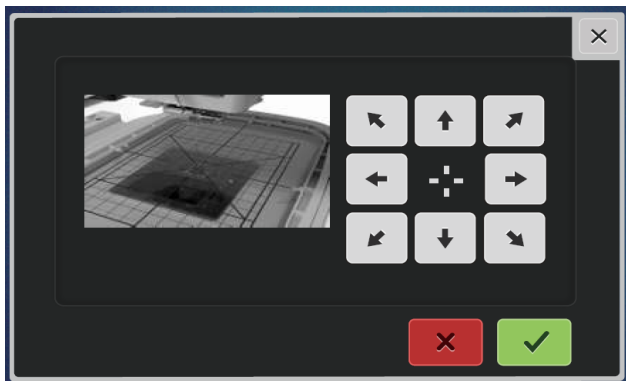

1. Use the fabric and stabilizer hooped in the Large Hoop from Page 6.
2. Place the hoop's plastic template into the inner ring of the hoop.
3. Attach the hoop to the machine. Refer to Page 7.
4. Touch the Setup Program icon.
5. Select the Embroidery Settings icon.
6. Select Calibrate the Hoop icon. The machine will automatically recognize the hoop that is attached.
7. If the needle is not positioned exactly in the center of the template, it must be centered using the arrow icons.
8. Confirm with the green check box; the adjustment is saved.











Thread Away

The Thread Away feature causes a swift movement of the hoop after a thread has been cut that pulls the top thread up out of the fabric and brings it out of the way so the top-side embroidery project will be perfectly clean with no thread to clip. This feature is always active.

NOTE: *Thread Away is always active and will engage anytime the thread is cut. Although the jump stitch length cannot be set in the machine, the jump stitch length can be changed in Toolbox Embroidery Software. Set it very short (e.g. 3pts) if you wish the thread to be cut between shorter jumps.*

Editing Designs

Customize embroidery designs using functions found on your embroidery machine. You will use the functions shown in the chart to customize designs on your particular model of embroidery machine as we go through the editing features on the following pages.

Function	Icon
Move Motif	
Mirror Image Left/Right	
Mirror Image Up/Down	
Change Motif Size- Proportionally (+/- 20%)	 
Rotate Motif	
Delete	
Check Motif Size	
Density	
Word Art / Text Bending	

Set Up For Editing and Stitching

Use the features and functions just learned to set up a design, and then stitch it out as we proceed through the next pages.



Select the design

1. Select the Embroidery Motifs folder.
2. Select Folder 5, Design #6.
3. The design will appear on the screen.
4. When starting a new design, it is best to check the hoop size. If a hoop is already on the machine, it will be selected. If no hoop is attached, the design opens in the hoop closest to the size of the design.
5. Check to make sure the proper foot sole is on the machine. Ensure that the Straight Stitch Plate is attached. The machine will recognize and display the stitch plate that is attached.

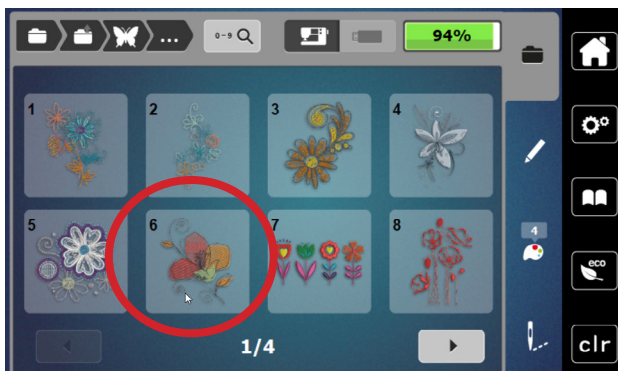

Sew HOW

Do you know to:

- Select the proper hoop?
- Access the Presser Foot Sole Display?

Editing - Rotate/Resize

Designs can be rotated in 90° increments using the +90° icon, or in 1° increments. Designs can be resized proportionately to a maximum of 20% up or 20% down by using the Multi-function knobs or the on-screen - / + icons

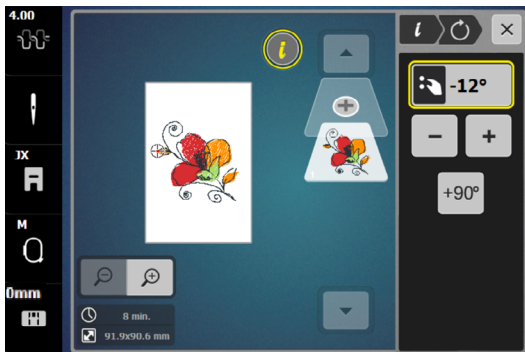
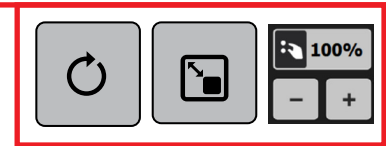

NOTE: If an icon is outlined in yellow, that indicates that a change was made using that feature or function.

Rotate Motif

1. Using the design from the previous page, select "i" to open the Information menu.
2. Touch the Rotate Motif icon. Touch the +90° icon. The design rotates 90° to the right. Continue touching the icon as it rotates to 180°, 270°, then back to 0°.
3. Use either the Upper Multi-function (Width) knob or Lower Multi-function (Length) knob to rotate the design in 1° increments. Turning either knob to the right will rotate the design to the right. Turning either knob to the left will rotate the design to the left. You can also use the - icon to rotate the design to the left, or the + icon to rotate the design to the right.
4. Rotate the design to -12°.

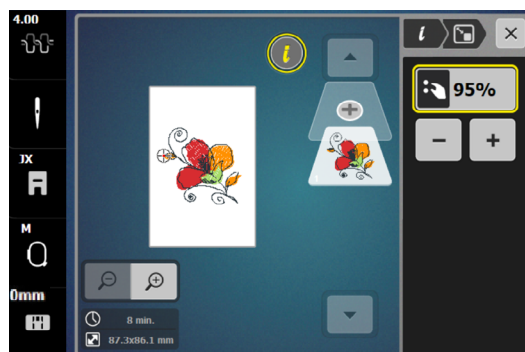

Resize

1. Touch the "i" in the breadcrumb path; touch the Change Motif Size icon.
2. Use the Multi-function knobs or the -/+ icons to proportionally resize the design to a maximum of 20% up or 20% down..
 - Turning either Multi-function knob to the right increases the size of the design; turning either knob to the left decreases the size of the design.
 - Touching the - icon decreases the size of the design; touching the + icon increases the size of the design.
 - Cancel any changes made by touching the percentage box.
3. Resize the design to 95% using either the -/+ icons or the Multi-function knobs.
4. Proceed to next page.



Tip: To save time and keep from having to close and reopen the "i" menu, use the "i" menu breadcrumb path to navigate within the information menu. This will allow the Information menu to remain open (available) for on-screen editing.

Sew HOW

Do you know how to:

- Rotate a design in single degree increments?
- Change the size of a design?

Editing - Mirror Image

Design motifs can be mirror imaged both in the left/right position or up/down position.

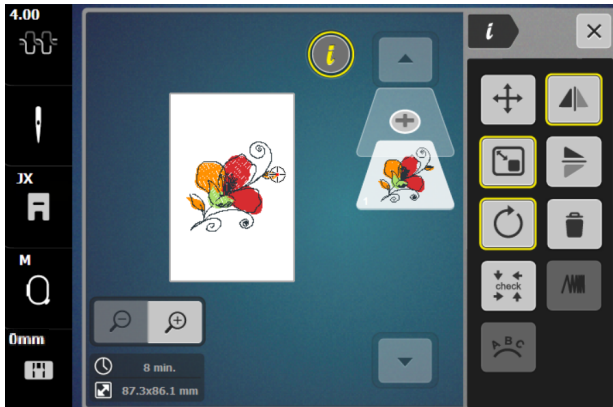
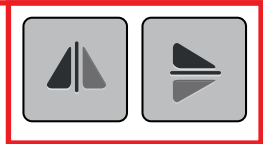

Mirror Image Left/Right

1. Using the same design from the previous page, select "i" to open the Information menu.
2. Touch the Mirror Image Left/Right icon.

Mirror Image Up/Down

1. Touch the Mirror Image Up/Down icon.
2. Touch the icon a second time to return it to the upright position.

Editing - Move Motif

Design motifs can be moved on screen using the Multi-function knobs, the - / + icons on screen, or by dragging and dropping.

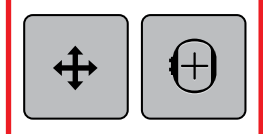

1. Touch the "i" in the breadcrumb path; select the Move Motif icon .
2. Use the - / + icons under the X box or the Upper Multi-function knob to move the design to the left or right on the screen.
3. Use the - / + icons under the Y box or the Lower Multi-function knob to move the design up or down on the screen.
4. Use your fingertip or the stylus to drag and drop the design into the desired position on the screen.
5. The X and Y coordinates can be cleared individually by touching the yellow outlined box.
6. To center the design on the screen, touch the Motif Center icon.

Editing - Adding/Deleting Designs

Additional designs can be combined directly on screen of the machine. Unwanted designs can be deleted quickly and easily.

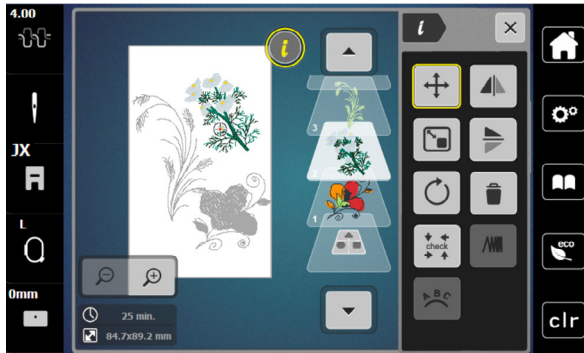
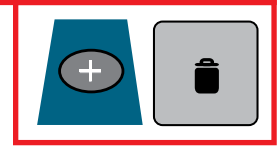

Adding a second design

1. To give more room to add designs, select the Large Hoop from the Hoop Selection menu.
2. With the design from the previous page on screen, touch the Add Motif (+) icon.

Note: The Add Motif icon is at the top of the Layer Panel. Scroll up if it is not visible on the screen.

3. Select Design 12 from Folder 5.
4. The design opens on the screen.
5. Touch Add Motif (+) icon again; select Design 13 from Folder 5.
6. Touch the "i" icon; then Move Motif.
7. Move the designs around on the screen using the Multi-function knobs, or by dragging and dropping.

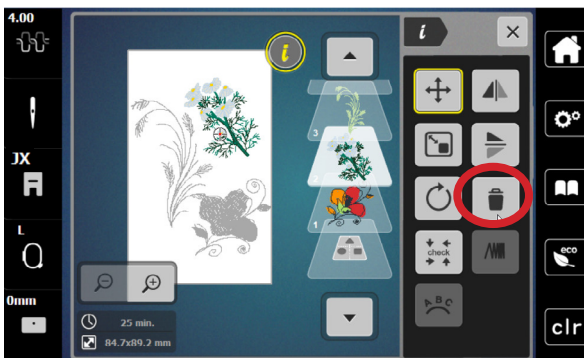

Deleting a design using Delete Motif icon

1. Select the daisy design in the Layer Panel.
2. Touch the "i" in the breadcrumb path; touch the Delete Motif (trashcan) icon.
3. A new screen will appear asking if you wish to delete the motif. Confirm by touching with the green check box.

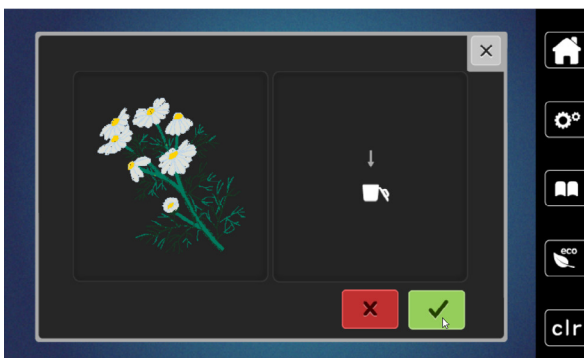

Move, rotate, mirror image as desired

1. Use the editing skills you learned from the previous exercises to position the designs as desired on the screen.
2. Proceed to the next page.

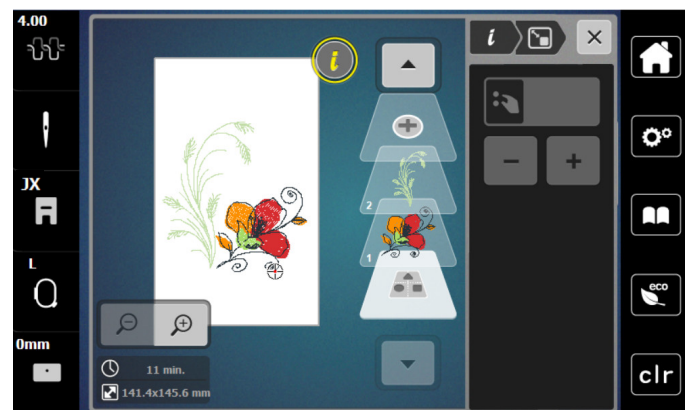

Centering a Combined Design In the Hoop

A new design that is opened on the screen will come in centered in the hoop. But if you have combined designs, or have perhaps moved the design around on the screen, the design will need to be centered in the hoop before sending the design to be stitched.

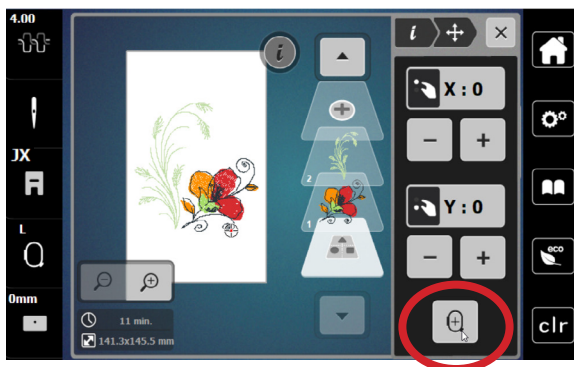
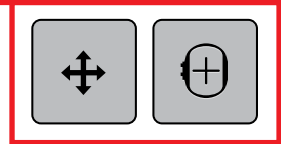

1. Using the same design from the previous page, select the bottom-most layer to select the entire design.
2. Touch the Move Motif icon.
3. Touch the Centering icon. (Alternatively, you could touch the X and Y icons to reset at 0.)
4. The design is now centered in the hoop.

Check Motif Size

Check, also known as Trace, is used to confirm the stitching area of a selected motif. After adjusting the position of a design within the hoop, use this feature to confirm that the design will stitch in the correct area and to verify placement of the embroidery motif on a project. Note: The b70 DECO also has a dedicated button on the outside of the machine to easily access this feature.

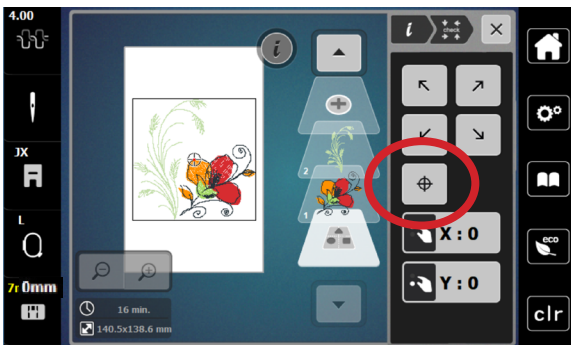
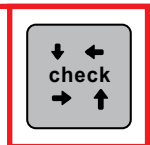

1. Fabric and stabilizer should be hooped. Attach the hoop to the machine.
2. Select "i"; then select Check Motif Size.
3. Touch each corner arrow to move the needle to the outer corners of the design in a box fashion. This provides a method to verify placement and size of the embroidery motif on a project. Use the Multi-function knobs to fine-tune placement.
4. Touch the Motif Center icon and the needle will move to the center of the design. Use the Multi-function knobs to fine-tune placement as you align the center needle position with marked center lines on the fabric.
5. Close the screen to return to the editing screen.
6. Proceed to next page.

Sew HOW

Do you know how to:

- Access the check feature in the machine?
- Move the design to ensure correct placement?

Placement: Absolute Check

The goal of Absolute Check is to check the points and boundaries of the design so that they embroider exactly where you want. You can check the location of any single stitch, even the most complex design.

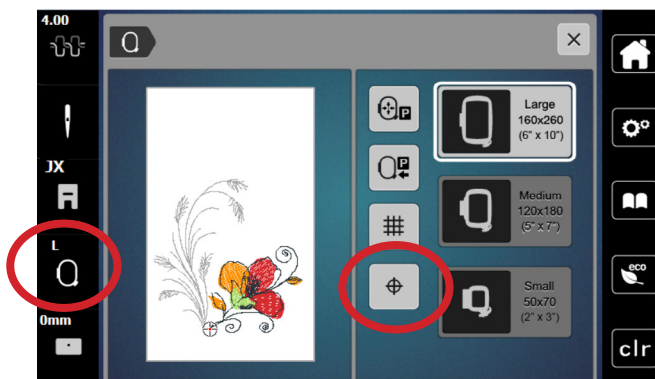
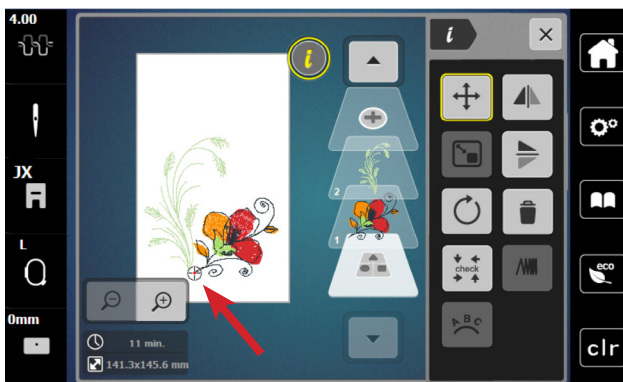
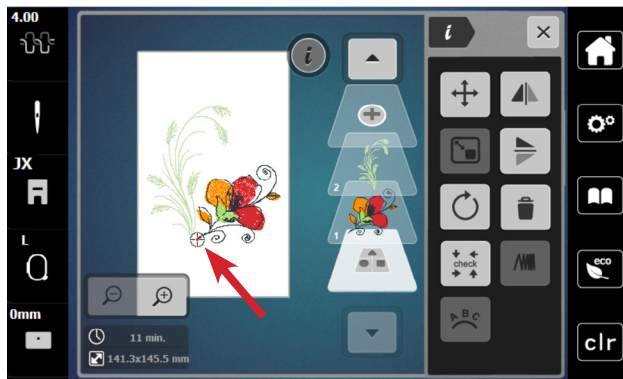

1. Use the design from the previous page. Fabric and stabilizer should still be hooped and attached to the machine. Select the bottom-most layer in the Layer Panel.
2. Draw a dot on the hooped stabilizer about 1" left of the center line in the lower part of the hoop
3. By default, the Absolute Check setting is active; therefore, when the motif is on the embroidery edit screen, reference points can be selected and checked for perfect placement.
4. Touch any point of the design on the screen and the needle will move to the location where that stitch would be taken on the hooped fabric. To fine tune placement, use the Move Motif icon.
5. Touch the screen at the bottom of the flower center as denoted by the cross hairs. The needle will move to the corresponding point on the hooped fabric.
Tip: Use the Zoom Tool (up to 9 levels) to zoom in to ensure the greatest accuracy.
6. Select "i"; Move Motif. Use the Multi-function knobs (or drag and drop) to position the needle over the dot marked in Step 2. (The point that you touch in Step 5 will stitch exactly over the dot marked on the fabric when you stitch the design.)
7. Proceed to the next page.

Note: Absolute Check is active by default. However, the Motif Center icon must be deactivated in order to apply Absolute Check. This can be double-checked by touching the Hoop Selection icon. Ensure that Motif Center is deactivated - that it is not outlined in yellow.

Sew HOW

Do you know:

- The difference between Check Motif Size and Absolute Check?

Change Thread Color

Quickly change thread color to suit your project and view the changes on the screen.

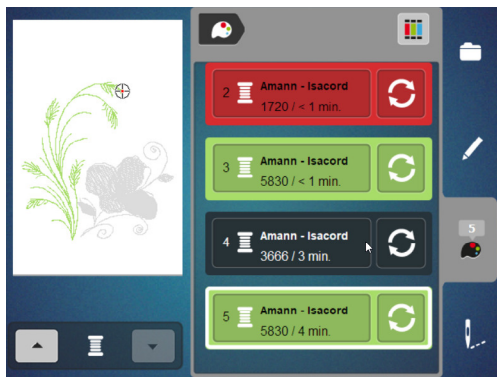

1. Using the same design from the previous page, select the Color Information tab (palette icon).
2. You can view the individual colors in the design by using the up/down arrows beneath the motif, or by touching a color bar to the right of the motif. Scroll up or down if not all color bars are visible on the screen.
3. Select Color 5. Note that Color 5 is the green stem design. The color bar will be outlined in white, and the green stem will appear in color on the display.
4. Select the Change Color/Thread Brand icon on the right of color bar.
5. There are two ways to change the color.
 1. Use the left/right arrows to scroll and find a color.
 2. Touch the 0-9 Search icon and type in a color number.
6. Select the 0-9 Search icon and type 5830 (the same green that appears in the flower). Touch the color bar that appears at the bottom of the screen.
7. The new color is assigned. Select Edit (pencil) icon to view the changed design.

Change Thread Brand

Easily convert the thread colors in a design from one brand of thread to another.

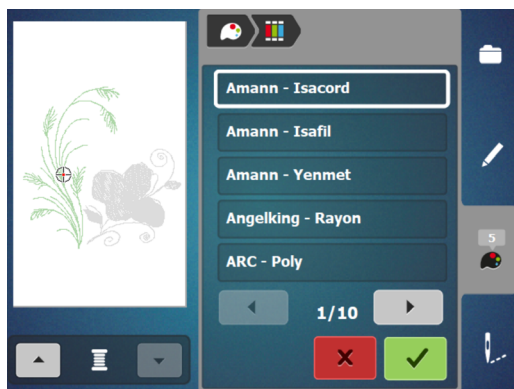
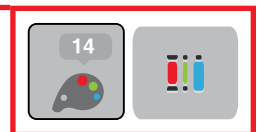

1. Select the Color tab (palette icon).
2. Select the Convert Thread Brand icon at the top right of the screen.
3. Use the left/right arrows below the thread brands to scroll until the desired thread brand name appears. They are arranged alphabetically.
4. Touch Confirm (green check).
5. The design colors have been reassigned with the closest color match for the particular brand you chose.
6. Repeat the process to change the thread brand back to Amann-Isacord.

Note: Thread brands can also be changed for individual colors by selecting the Color/Thread Brand icon on the right of the Color Bar.

Changing To Single Color Embroidery

To stitch a multi-colored design in one color, set your machine to bypass color changes by selecting the Single/Multi Color Motif icon. The machine will not stop at the end of the colors in the design. If the design is already a single color design, this icon will not be visible.

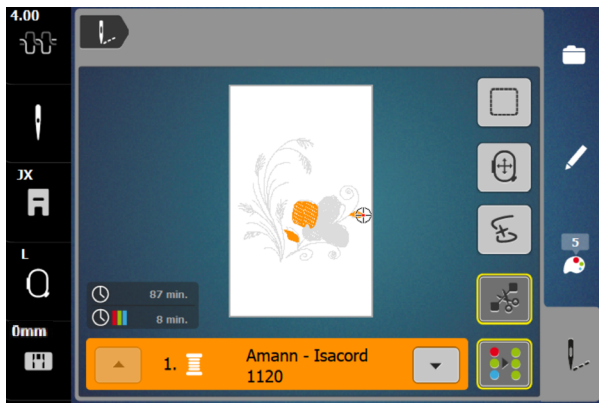
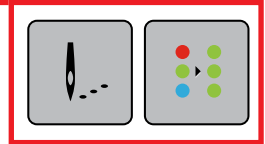

1. With the design from the previous page on the screen, touch the Embroidery menu (needle icon).
2. Touch the Single/Multi Color Motif icon.
 - If the symbol is active, outlined in yellow, the machine will not stop at the color changes and the entire motif will be stitched with the color threaded into the machine.
 - If the symbol is inactive (no yellow outline), the machine will stop at color changes for thread changes.
3. Deactivate Single Color Embroidery (no yellow outline) so the design will be stitched in multiple colors.

Adding a Basting Box

Preprogrammed basting outlines stitch around a selected design. This serves as an additional anchoring to hold the fabric and stabilizer together. If using a water soluble stabilizer topping, it is helpful to baste it in place before embroidering.

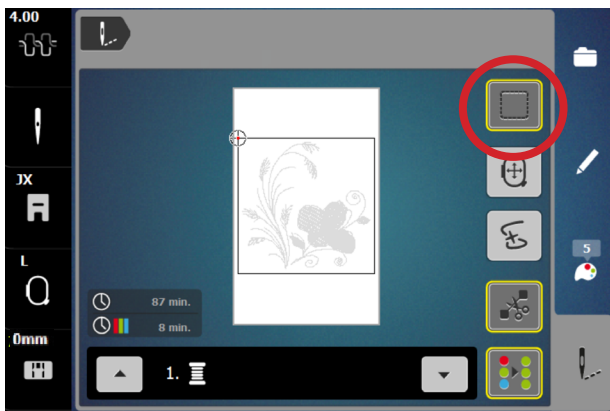
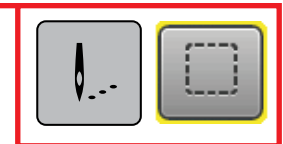

1. Touch the Basting Box icon.
2. Toggle the icon between the choices of basting. A yellow outline indicates basting is activated.
 - No basting (no yellow line)
 - Basting around the design
3. For this exercise, select No Basting (no yellow outline) and proceed to the next page.

Sew HOW

Do you know:

- How to engage a design basting box?
- Stitch a design as a single color?

Stitching a Design

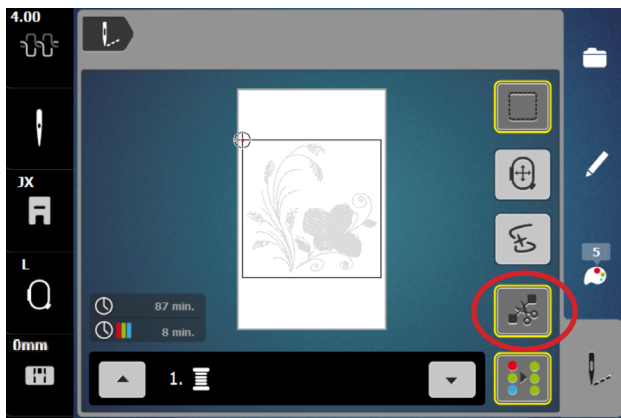

1. You should already be in the embroidery screen. If not, touch the Embroidery (needle) icon.
2. Engage the Cut Connecting Stitches icon (denoted by a yellow outline around the icon) so that the connecting stitches between the embroidery motifs will be cut. 
3. While in the Embroidery screen, press the Start/Stop button to begin stitching.

Note: When stitching a design, the machine will stop after about 7 stitches and wait for the user to trim the thread tails. This feature can be turned off so that the machine will not stop. Select Setup > Embroidery Settings > Automatic Cut > Thread Cut After Starting Embroidery. Turn this feature off.

4. Sometime during the stitching process, stop the machine and cut the thread to simulate a thread break. Follow the steps for using the Sequence Control function on the following pages. 
5. Change thread as prompted on the screen.
6. When the motif is complete, touch the Confirm (green check) icon. The Edit screen will reappear.

IMPORTANT TIP:

A crucial factor in successful machine embroidery is regular cleaning and oiling. This will keep your machine running smoothly. Refer to your machine's manual and Page 30 of this workbook for more information. Follow your dealer's guidelines for routine checkups and maintenance.

Sequence Control

Use the Sequence Control function when the thread breaks to reposition the needle to start stitching again. The Sequence Control function is also used for advancing or backing up CutWork Designs.

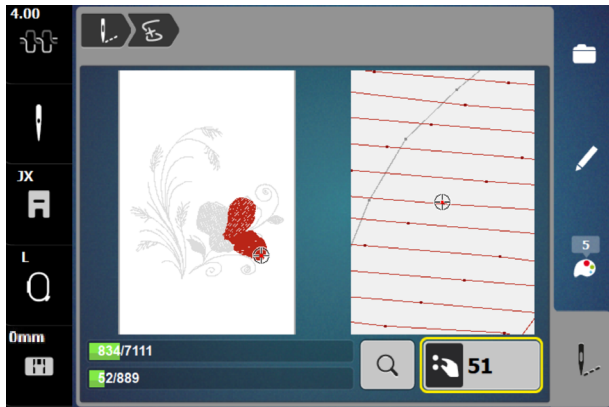
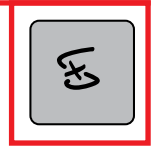

1. If a thread breaks during the embroidery process, the machine will stop and the Sequence Control screen will automatically appear.
2. For today's exercise, stop the machine sometime during the stitch out of the design from Page 21. Cut the thread using the Thread Cutter on the machine.
3. Touch the Sequence Control icon to open the Sequence Control screen. (This screen opens automatically if the machine detects a thread break.)
4. When the Sequence Control screen opens, the motif is enlarged for a better view of the exact place of the thread breakage and the Information Area appears.
5. Turn the Upper Multi-function (Width) knob counter-clockwise to move the embroidery hoop backward in the embroidery sequence. Turn the Upper Multi-function (Width) knob clockwise to move the embroidery hoop forward in the embroidery sequence.
6. Turn the stitch width knob slowly to move the hoop stitch by stitch.
7. Go back stitch by stitch to a position several stitches before thread breakage occurred to resume stitching.
8. To resume stitching, touch the Start/Stop button on the machine, or touch the Needle icon in the upper left corner of the display and the Embroidery screen reappears.

Tips:

The left portion of the display shows the position of the needle where it appears in the overall design. The right side of the display is an enlarged view of the position.

Use the Upper Multi-function (Width) knob to move the hoop slowly stitch by stitch as described above.

Use the Lower Multi-function (Length) knob to move the embroidery hoop in larger steps.

The number in the Information area shows the exact stitch number of the embroidery sequence. Touch the Selection of Stitch Position by Number (magnifier) icon, a screen appears where you can type in the exact stitch number to which you would like to move to.

Changing Lettering Size

Enter single letters or words and use the Resize Motif icon to resize the motif proportionally up to 20% larger or smaller.



NOTE: Use the *Stitch Properties* icon to increase/decrease stitch density. Increasing density may be helpful on towels to prevent terry loops from coming through the embroidery. Refer to Page 26 and your machine's manual for more details.



1. In the Selection menu, select the Embroidery Motif folder. Select Folder 1, Design 13. **Optional:** Select the Color Information tab (palette) and change the color to black (Isacord 0020).
2. Select the Add icon (+); Alphabets Folder; Alphabet #1.
3. Enter "hand" in all lower case letters; touch the green check box to Confirm. Move "hand" to the upper part of the frame using the stylus or the Multi-function knobs.
4. Select the Add icon (+); Alphabets Folder; Alphabet #1.
5. Enter "made" in all lower case letters; touch the green check box to Confirm. Move "made" to the lower part of the circle using the stylus or the Multi-function knobs.
6. With "made" still selected, touch the "i" icon and select the Change Motif Size icon. Use either the Upper or Lower Multi-function knob (or the - / + icons) to reduce the size proportionately to 90%.
7. Touch "hand" in the Layer Panel.
8. Use either the Upper or Lower Multi-function knob (or the - / + icons) to reduce the size proportionately to 90%.

Word Art - Changing Lettering Spacing

Although letters added to the screen are mathematically spaced, sometimes certain combinations of letters will appear to be too close together or too far apart. Using Word Art (Text Bending) will allow flexibility in the spacing of the lettering.



1. Notice that the "a" and the "n" appear too close together on the screen.
2. Select the word "hand" in the Layer Panel.
3. Touch the "i" in the breadcrumb path and select the Word Art icon.
4. Use the Upper (Width) Multi-function knob (or the -/+ icons in the upper area of the screen) to change the spacing.
 - Turning the knob to the left (or touching the - icon) decreases the spacing between the letters.
 - Turning the knob to the right (or touching the + icon) increases the spacing between the letters.
5. Increase the spacing to approximately 20, or until the spacing is visually pleasing.
6. Proceed to the next page.

Word Art

Use Word Art to create curved lettering baselines. You will use the Lower Multi-function (Length) knob or the lower set of +/- icons to change the baseline.

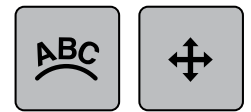

1. Word Art should still be open in the "i" menu.
2. The word "hand" should still be selected.
3. Turn the Lower Multi-function knob to the right (or use the + icon at the lower part of the screen) to bend the letters as shown (maximum of 100).



4. Select the word "made" in the Layer Panel.
5. Turn the Lower Multi-function knob to the left (or use the - icon at the lower part of the screen) to bend/arc the letters as shown (maximum of -100).

NOTE: You may need to move the words or change the spacing after bending the letters so there is no overlap.



6. To center the combined design, select the bottommost layer in the panel (the layer with no number).
 7. Select the "i" in the breadcrumb path and select Move Motif.
 8. Select Center the Motif.
- NOTE:** a combined design should be centered before being stitched out.
9. Follow the directions on Page 25 to save this design.
 10. If desired, stitch this design out as homework.

Saving and Deleting Designs

Designs can be saved into the Personal Embroidery Motifs Folder on the machine or to a USB stick inserted into the machine. Saved designs can also be retrieved from the Personal Embroidery Motif folder or from the USB stick.

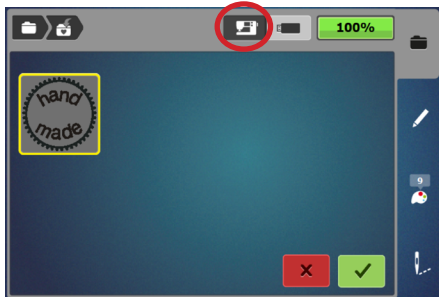

Saving a design to the machine:

1. The design you wish to save must be open on the embroidery screen. Touch the Selection menu; select the Save Motif icon. The motif to be saved is displayed with a yellow outline around it.
2. To save the design to the machine's Personal Embroidery Motifs folder, touch the Embroidery Machine icon at the top of the screen.
3. Touch the motif to be saved (outlined in yellow) or the Confirm icon. The design is saved in the machine and the Edit screen reappears.
4. Go through this process to save the design a second time so that one can be deleted in the Deleting a Design section below.

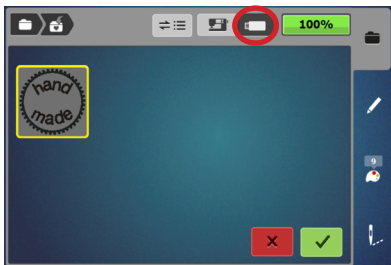

Saving a design to a USB stick:

1. In the Selection menu, select the Save Motif icon. The motif to be saved is displayed with a yellow border around it.
2. Insert a USB stick into the machine; touch USB Stick icon at the top of the screen.
3. Select the motif to be saved (outlined in yellow) or touch the Confirm icon. The embroidery motif is saved on the USB stick, and the Edit screen reappears.



Deleting a design:

1. Touch the Selection menu; select the Delete (trashcan) icon.
2. Select the folder that contains the motif to be deleted (Embroidery Machine>Personal Embroidery Motif Folder or the USB icon).
3. In this exercise, select the Embroidery Machine/Personal Embroidery Motifs Folder. Select one of the lettering motifs.
4. In the Delete screen, select the green check box to confirm; the motif is deleted. (If you did not wish to delete the chosen design, you would select the red x box.)
5. Touch the Edit (pencil) icon to return to the Edit screen.

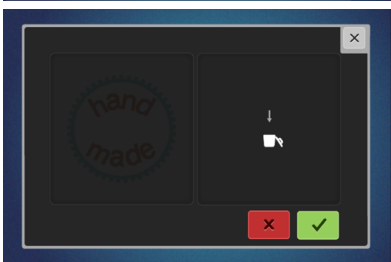

Retrieving a Saved Design

1. In the Selection menu, select Open New Motif and select either the USB Stick icon or Personal Embroidery Motif Folder.
2. Select design of choice and the Embroidery Edit screen opens with the selected design.

Note: When opening a design from a USB stick, you have the choice to see a preview of the design or the design name.



Note: When saving a design and a USB stick is inserted, the save folder defaults to the Personal Designs Folder. You then have the choice to save to the Personal Designs Folder or to the USB Stick. If no USB stick is inserted, the default will be the Personal Embroidery Motif folder.

Alter Stitch Density-Lettering

Change the stitch density of lettering to complement different fabric types. This is helpful when enlarging lettering. .



Stitch Density

1. Select the Alphabets Folder; select Alphabet #5.
2. Enter the letter B; touch Confirm (the green check box).
3. Touch the Hoop Selection icon and select the Large Hoop. Close the Hoop Selection menu.
4. Move the B to the left.
5. Select the Add Motif icon at the top of the Layer Panel.
6. Select the Alphabets Folder; select Alphabet #5. Type the letter "B" and Confirm.
7. Again select the Add Motif icon at the top of the Layer Panel.
8. Select the Alphabets Folder; select Alphabet #5. Type the letter "B"; Confirm.
9. Move this "B" to the right.
10. Visually align the three B's.
11. Touch the left B on the screen. Select "i"; select Embroidery Stitch Density; alter satin density to 60%.
12. Select the center B on the screen; leave density at 100%.
13. Touch the right B on the screen; alter satin density to 140 %
14. Select the Zoom icon and zoom in to notice the difference in the density of the letters.

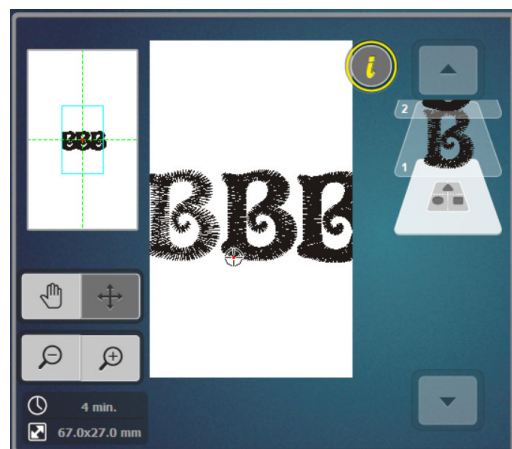
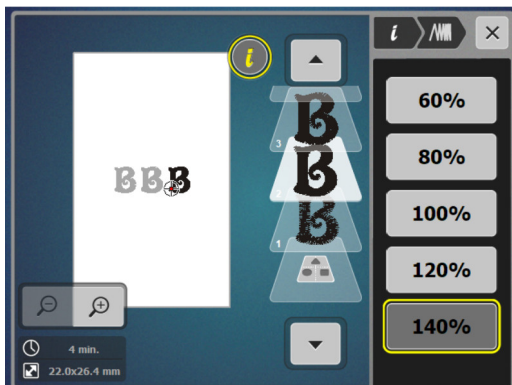

Reference - Embroidery Needles

For most embroidery, an embroidery needle is the best choice. These needles are designed with a larger eye than normal to prevent thread fraying, and are also designed to withstand the high speeds of the embroidery process.

Needle Use & Care

- Change needles every 2-3 hours or about every 50,000 stitches.
- Change the needle if you are experiencing looping or skipped stitches.
- Never use a bent needle or dull needle.

Needle Size

- 75/11 and 80/12 are the two most commonly used sizes.
- For heavy fabrics, use a larger needle (higher number).
- For lightweight fabrics, use a smaller needle (lower number).
- For dense designs, use a small needle so that it will slide into the stitches easier.

Universal Embroidery Needles

- These are the most widely used for embroidery. They have a slightly rounded ballpoint tip.

Ballpoint Embroidery Needles

- Ballpoint needles are designated by the letters SUK.
- They are shown to have positive results when embroidering with metallic thread. (Due to the wiry nature and memory of this type of thread, a traditional embroidery needle with a sharp point can cut the thread, causing breakage. Ballpoint needles are blunt enough to avoid this.)

Titanium-coated Embroidery needles:

- Last 3 times longer than regular embroidery needles.
- Work well with all embroidery designs and fabric types.
- Are especially useful when using an adhesive-coated stabilizer, because the coating resists adhesive build-up as the needle moves in and out of the fabric.
- Are often gold-colored.
- Should be changed after 90,000 or more stitches.

Specialty Needles

- Occasionally other needles may be recommended for specially digitized techniques, such as a Wing Needle for heirloom embroidery.



Reference - Embroidery Threads



EMBROIDERY THREAD

Most designs are digitized for 40-weight thread. 40-weight polyester thread is the most commonly used types by machine embroiderers.

Always select high-quality embroidery thread. Bargain brands may cause excessive thread breakage while stitching, and may produce undesirable final results.

Polyester Embroidery Thread

- Widely available
- Beautiful, rich look
- Colorfast
- Abrasion-resistant
- Great for children's clothing
- Generally more economical than rayon

Rayon Embroidery Thread

- Widely available
- Beautiful, rich look
- Higher sheen than polyester embroidery thread, but generally more fragile.

Specialty Embroidery Thread

These threads are more fragile and are most often using as accents rather than for full designs.

- Metallics
- Acrylics
- Silk

BOBBIN THREAD

For best results, use a high quality 60-wt thread in the bobbin.

- Lightweight thread helps avoid thread build-up on bottom side of the project.
- It is designed to withstand the high-speed stitching of an embroidery machine.
- Lightweight thread allows more bobbin to be wound on bobbins, so you will be changing bobbins less frequently than with heavier thread.
- It is more economical than regular embroidery thread.
- Use neutral thread color throughout design.
- White or off-white is the most commonly used color.
- Embroidery bobbin thread is readily available by a number of manufacturers.

Reference - Stabilizers

Stabilizers are an essential ingredient for successful embroidery. Stabilizers support the fabric as the design is embroidered to prevent puckering and tunneling of the stitches.

Stabilizers are classified as to how they are removed from the fabric after stitching.

- Cut Away
- Tear Away
- Wash Away

Cut Away Stabilizers

- Most commonly used stabilizer in commercial embroidery
- Support a large number of dense stitches
- Excess stabilizer is trimmed away after stitching, leaving about ¼" of stabilizer around the edges of the design
- Stabilizer remaining behind the stitches continues to support stitches throughout life of garment/project
- Available in several widths to fit different hoop sizes
- Available in white, black, and beige
- Available in several weights
- Available in fusible, non-fusible, and pressure-sensitive adhesive (sticky backed) versions

Tear Away Stabilizer

- Most commonly used type of stabilizer
- Excess stabilizer is carefully torn away after stitching is complete
- Available in light, medium and heavy weight
- Available in white and black
- Available in fusible, non-fusible, and pressure-sensitive adhesive (sticky backed) versions, as well as water-activated adhesive versions
- Available in several widths to fit different hoop sizes

Water-Soluble Stabilizer

- Used for backing and topping, in single or multiple layers
- Easily removed with water
- When used as a topping, keeps stitches from being lost in heavily napped fabrics such as velvet and corduroy
- Available in different weights, and also as an adhesive version



Stabilizer Tips:

Use a cut away stabilizer when working with knits or stretchy fabrics.

Use a tear away when you want most of the excess stabilizer on the back to be removed.

Use a water-soluble stabilizer when you want no traces of stabilizer to remain on the back of the project.

Use a water soluble stabilizer when creating stand-alone lace.

Keep a minimum of one roll or package of each of the three types so you'll be ready for almost any stitching situation.

For more information on stabilizers, refer to the [Just Embroider It - e Book: All About Stabilizers](#) on bernina.com.

Reference - Cleaning And Oiling

One of the most important parts of maintaining your machine is proper cleaning and oiling. Below are tips to follow, but more complete instructions for your specific model can be found in your machine's manual.

It is recommended that you clean and oil every other bobbin, or every 3-4 hours of actual sewing time. If you notice your machine sounding louder than usual, then it is time to clean and oil.

General Cleaning Steps

- Turn the machine off and disconnect it from the power supply system.
- Clean the display using a soft slightly damp microfiber cloth.
- Remove the needle. (It is recommended that you change your needle every 4-6 hours of sewing time.)
- Remove the stitch plate.
- Clean the hook race with a brush and remove all lint and threads, using the brush included with your machine..

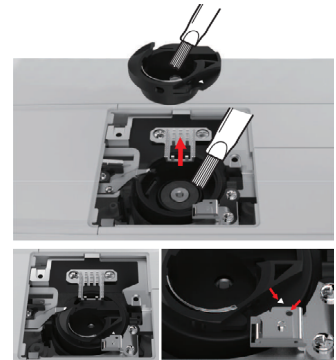

Oiling the Needle Bar

If the needle bar lacks lubrication, the needle bar might not move smoothly. If the machine is used often, the needle bar should be oiled every 6 months.

- Turn the machine off and disconnect it from the power supply.
- Remove the plug (1) and remove the screw (2).
- Remove the face cover (3). After removing the face cover, be careful of the moving parts.
- Put one drop of oil on the needle bar movement mechanism, including needle bar crank rod/needle bar bracket and needle bar supporter (add the oil on the area marked by arrow).
- Remove the presser foot.
- Turn the handwheel a few times and remove excess oil with a cloth.
- After oiling, the face cover must be remounted before plugging in the machine. Never reconnect the machine or make it run with the place cover removed.

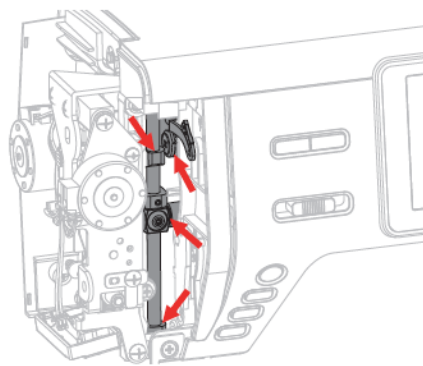
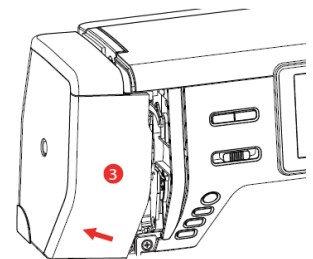
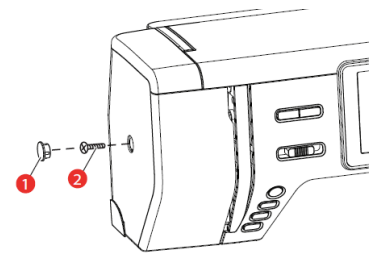

b79 and b70 DECO Embroidery Functions

External Buttons

1. Start/Stop
2. Presser Foot Up/Down
3. Auto Thread Cutter
4. Quick Reverse
5. Slide Speed Control
6. Thread Up Command
7. Securing



External Buttons

1. Start/Stop
2. Presser Foot Up/Down
3. Auto Thread Cutter
4. Light
5. Slide Speed Control
6. Thread Up Command
7. Check Motif Size



EMBROIDERY MOTIF SELECTION

	Alphabet Folder		Embroidery Motifs Folder		Personal Embroidery Motifs		
	Open New Motif		Add Motif		Save Motif		Delete Motif
	Embroidery Machine Select Motifs from Folders		USB Stick Select Motifs from Stick		Confirm		Cancel

EMBROIDERY FUNCTIONS

	Upper Thread Tension		Edit Embroidery Motifs		Zoom In (1-x times)		Embroidery OK
	Needle Selection		Add Motif		Zoom Out (1-x times)		Basting-Motif
	Presser Foot Display/ Presser Foot Selection		Information (i-dialog)		Moving the View		Move the Hoop
	Embroidery Hoop Display/ Selection		Move Motif		Color Tab		Sequence Control
	Stitch Plate Selection/Display		Center Motif in Hoop		Convert Thread Brand		Cut Connecting Stitches
	Home		Mirror Image Left/Right		Change Color/Thread Brand		Single/Multicolor Motif
	Setup		Mirror Image Up/Down		Confirm		Permanent Thread Tension
	bernette Embroidery Tutorial		Altering the Size		Close / Cancel		Securing Stitches On/Off
	Help		Rotate Motif		Selection by Number		Speed Adjustment in Setup
	Eco		Delete		Move Hoop to Center		Adjusting Thread Cut
	Clear - Back to Basic Setting		Check Motif Size		Move Hoop to Left		Automatic Cut After Thread Change
	Use Upper Multi-function Knob for Adjustment		Density		Grid On/Off		Thread Cut After Start of Embroidery
	Use Lower Multi-function Knob for Adjustment		Word Art / Bend Text		Motif Center		Fabric Thickness
	Use Either Multi-function Knob for Adjustment						

Absolute Check is a feature of both the b79 and b77. There is not an icon for this feature.