

MY bernette

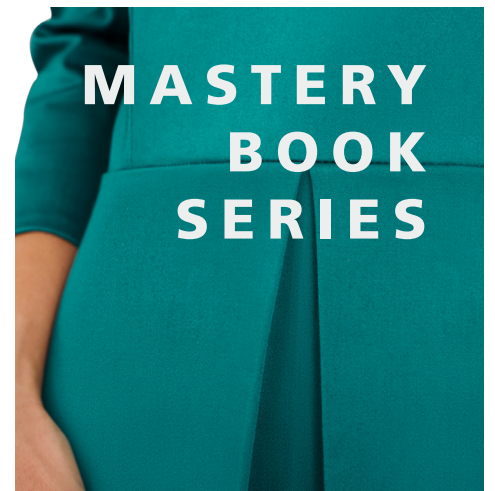

bernette SEWING MACHINE WORKBOOK
For bernette 79 and bernette 77



bernette SEWING MACHINE WORKBOOK

TABLE OF CONTENTS

TABLE OF CONTENTS.....	2	Saving Stitches in bernette Personal	
INTRODUCTION	3	Program	19
Preparing to Stitch	4	Triple Straight Stitch	20
Personalize the Screen.....	5	Vari-Overlock Stitch.....	21
Activate/Deactivate Beginning Tie-Off	5	Basting	22
Program the Thread Cutter	5	Blind Hem	23
Breadcrumbs.....	6	Stretch Stitch	24
Programming the Securing Button	6	Balance.....	25
Program Needle Stop Down and Hover ...	7	Automatic Buttonhole.....	26
Program the bernette Foot Control.....	7	Automatic Buttonhole-Corded.....	27
Stitch Selection	8	Attaching Buttons.....	28
Presser Foot Sole Display	9	bernette Creative Consultant.....	29
Security Program-Needle	10	Combi Mode-Stitch Patterns.....	30
Security Program-Stitch Plate Selection..	10	Combi Mode-Lettering	31
The 'i' menu.....	11	Free-Motion Stitching	32
bernette Dual Feed	11	bernette Stitch Designer Overview-b79..	33
Needle Stop Up/Down-bernette Free Hand		bernette Stitch Designer - b79 Only.....	34
System.....	12	bernette Stitch Designer - b79 Only.....	35
Securing Stitches	13	bernette Stitch Designer - b79 Only.....	36
Permanent Reverse/Backstepping.....	14	Reference - Sewing Machine Needles.....	37
Mirror Image/Pattern Repeat	15	Reference - Sewing Machine Needles.....	38
Pattern Functions - Pattern Begin/End....	16	Reference - Threads	39
Pattern Functions-Pattern Repeat/Extend ...	17	Reference - Decorative Stitching.....	40
Altered Stitches	18	Reference - Cleaning and Oiling	41
Temporary Altered Memory	19	b79 and b77 Sewing Functions.....	42

INTRODUCTION

Congratulations on the purchase of your new bernette sewing machine. The information in this workbook will help you learn the basics of using your new machine.

This workbook is designed to be used as a step-by-step guide to familiarize you with the basic operation of your bernette sewing machine. Once you have completed the exercises designated for your machine, attach the sewn samples to the information pages (or add a facing page for mounting) and insert the pages into plastic page protectors to store in a 3-ring binder. They can then be used as a reference tool in the future as you use your machine and explore the creative possibilities it affords.

Stitch and function charts for each bernette model are found on Page 42. Each stitch exercise page has a graphic of the stitch(es) used so you can more easily locate it on your machine.

Some pages with a stitching exercise end with a "Sew How" box. This mini-quiz will let you test your knowledge and review the points related to the exercise.

Working through this workbook is just the first step. Using the information on a regular basis will help make it become part of your regular sewing skills.

Instructional videos, inspiring projects and machine information can be found on mybernette.com.



www.mybernette.com



www.mybernette.com/b79 www.mybernette.com/b77

The information in this workbook applies to the bernette 79 and bernette 77 sewing machines.

NOTE: Some exercises apply only to certain models equipped with the feature being highlighted.

Preparing to Stitch

CLEANING AND OILING

Keeping your machine clean and well oiled will keep your machine running smoothly. This is a crucial component for successful machine stitching. Refer to Page 41 for cleaning tips. Your machine manual will also give you detailed cleaning and oiling suggestions.

STITCH PLATE

Attach the 7 mm Stitch Plate. The machine will recognize the stitch plate that is attached.

RAISE FEED DOGS

The feed dog raise/drop control is a slider at the bottom of the free arm, just to the left of the bobbin area. The feed dog automatically raises on the b79 when the embroidery module is removed.

PRESSER FOOT

Attach the Zigzag Sole (DA) to the machine. Engage the Dual Feed mechanism.

THREAD THE BOBBIN FOR SEWING

1. Wind a bobbin.
2. Open the bobbin cover by pushing the release button to the right. (Diagram 1)
3. Insert the bobbin so that the thread runs counterclockwise. (Diagram 2)
4. Pull the thread into the slit. (Diagram 3 - See 1)
5. Stabilize the bobbin by gently holding it in place.
6. Follow the arrow markings to bring the thread into the bobbin thread guide. (Diagram 4)
7. To cut the excess thread, take the thread end and pull it over the thread cutter. (Diagram 5 - See 2)
8. Close the bobbin cover.

Diagram 1

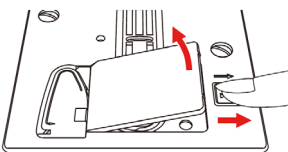

Diagram 2

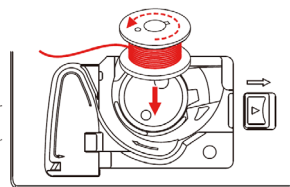

Diagram 3

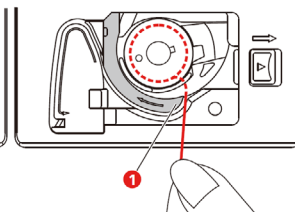

Diagram 4

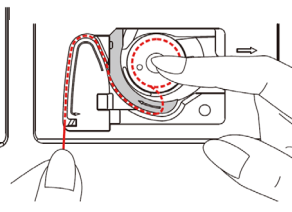
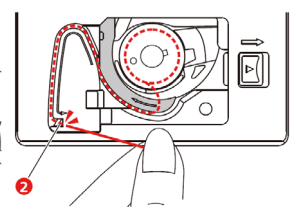

Diagram 5



INSERT AND THREAD NEEDLE (Refer to Page 37 and 38 for additional information on needles.)

- Use the proper needle for the thread and fabric being used. It is advisable to insert a new needle for each project, or after every 4 to 6 hours of sewing time.
- Always thread with the presser foot up. This opens the tension discs and allows the thread to seat properly.

THREADING TIPS FOR MODELS WITH BOTH HORIZONTAL AND VERTICAL SPOOL PINS:

- Use the horizontal spool pin with cross-wound threads; match spool cap size to end of spool.
- The smallest spool cap fits into the end of large cones/spools such as Isacord embroidery thread.
- Use the vertical spool pin with stacked threads and for some decorative threads (metallic threads); use the foam disc under the spool to avoid extra tension on the thread.

Personalize the Screen

You can personalize the display color to suit your individual tastes. Change the color in the Setup Program.

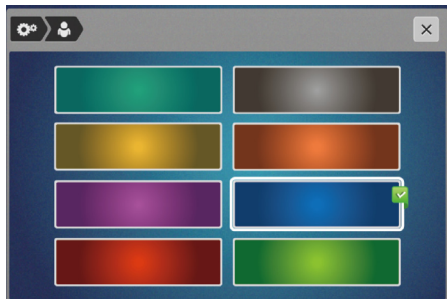

1. Touch the Setup icon.
2. Select Personal Settings and a display appears.
3. Select the desired color.
4. Close the screen (or use the setup breadcrumb path to navigate back to Setup).

Activate/Deactivate Beginning Tie-Off

Activate or deactivate the 4 securing stitches at the beginning of every stitch/stitch type. If activated, the tie-off stitches at the beginning of every stitch.

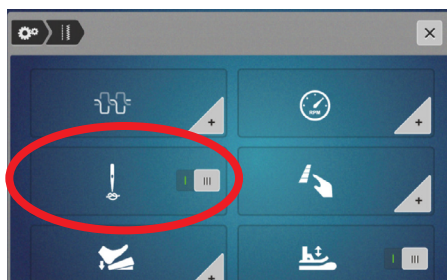

1. Select Setup.
2. Select Sewing Settings.
3. The slider next to the Securing Stitches at Pattern Begin will activate or deactivate the tie-off at the beginning of the stitch. (This is a switch for on/off.)
4. Toggle the switch to off for today's lesson.
5. Close the screen (or use the setup breadcrumb path to navigate back to Setup).

Program the Thread Cutter

The automatic securing can be programmed before the thread cut takes place.



1. Select Setup. Select Sewing Settings.
2. Select Programmable Buttons, then the Thread Cutter icon.
3. Touch the Securing icon to activate 4 securing stitches before cutting. Touch the - / + icons to program the number of securing stitches. Touch the Securing icon again to deactivate automatic securing.
4. Leave this screen open and proceed to the next page.

Breadcrumbs

Learn to navigate within menus using the icons in the breadcrumb path rather than using the Close box to exit. This is a time-saving feature when setting preferences within several menus in Setup, embroidery motif selection, and the "i" menu in sewing and embroidery.

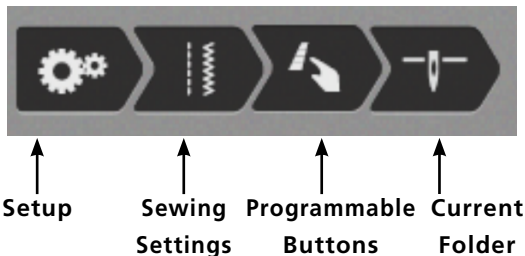

1. Note the breadcrumb path at the top of the display.
2. Touching any of the icons in the breadcrumb path will take you back to that particular menu. This is a time saver when changing multiple settings within a menu.

Programming the Securing Button

The number of securing stitches that are sewn when using the Securing Button on the machine can be programmed.

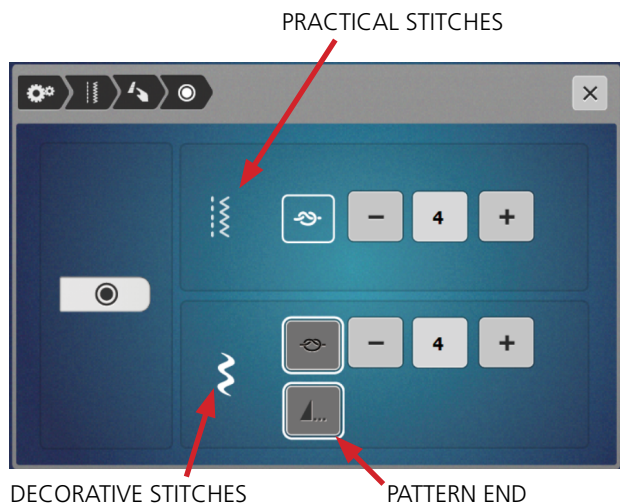

1. Select Programmable Buttons in the breadcrumb path.
2. Select the Securing icon.
3. In the Practical Stitches area, touch the - / + icons at the top of the display to program the number of securing stitches for practical stitches. For lessons in this Workbook, leave this at the default of 4.
4. Touch the Securing icon at the lower part of the display to activate automatic securing for decorative stitches and combined stitches.
 - Touch the - / + icons to program the number of securing stitches.
 - Touch the Securing icon again to deactivate automatic securing for decorative or combined stitches.

For today's lessons, leave this at the default of 4.
5. Pattern End is activated by default (denoted by white outline). This will secure the stitches at the end of a stitch pattern. Leave this icon activated for this lesson.

Sew HOW

Do you know how to:

- Use the breadcrumb path to navigate?
- Program automatic securing for practical and decorative stitches?

Program Needle Stop Down and Hover

Take advantage of Hover when stitching with Needle Stop Down engaged. When the stitching stops with Needle Stop Down engaged, the machine can be programmed to stop with the presser foot down or to hover.

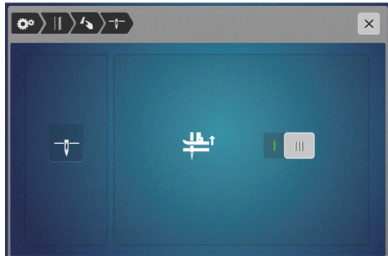
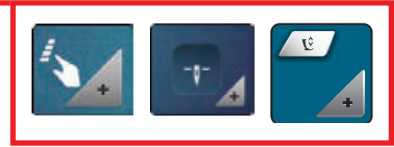

1. Select Programmable Buttons in the breadcrumb path..
2. Select the Needle Stop Down icon.
3. Touch the switch to activate Needle Stop Down.

Note: *If you should wish to deactivate Hover entirely, this switch should be set to off.*

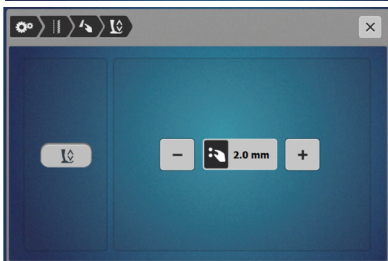

To set the height of the hover position:

1. Select Programmable Buttons in the breadcrumb path.
2. Select Program the Hovering Position of the Presser Foot.
3. Turn the Multifunction knobs (or touch - / +) to adjust the distance between the stitch plate and the presser foot from 1 mm to 6 mm. Leave the setting at the default of 2 mm for these lessons.

Program the bernette Foot Control

The bernette Foot Control with Back-kick can be programmed with desired settings. The Foot Control default setting is to raise or lower the needle when the heel of the foot control is depressed. The Programmable Foot Control back-kick options also allow the heel-down to signal a tie-off, cut the thread, and raise the presser foot.

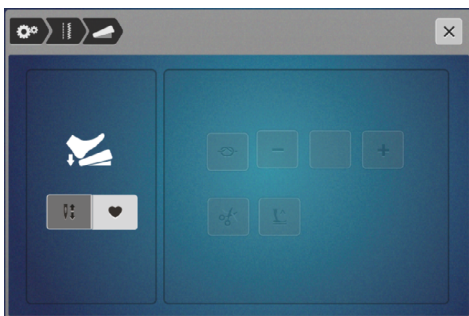

1. Using the breadcrumb path, navigate back to the Setup menu; select Sewing Settings.
2. Select the Foot Control icon.
3. If the Needle icon is selected, the back-kick will move the needle to the next position.
4. Select the Heart icon. The back-kick can be programmed in a number of ways:
 - When the Securing icon is selected, the number of securing stitches can be programmed for two to six securing stitches in place. The standard is 4 stitches.
 - When the Automatic Thread Cutter icon is selected, the upper and lower threads are cut automatically by the back-kick.
 - When the Presser Foot Lift icon is selected, the presser foot raises when using the back-kick.
5. For the class exercises, program the Foot Control to raise or lower the needle. Select the Needle Up/Down icon.
6. Exit the Setup menu.

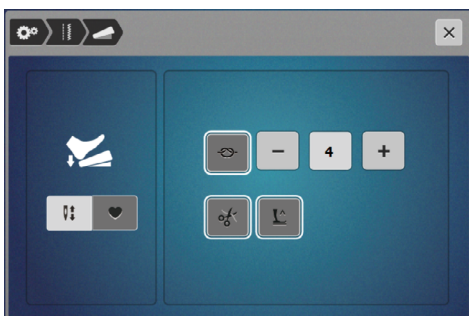

Stitch Selection

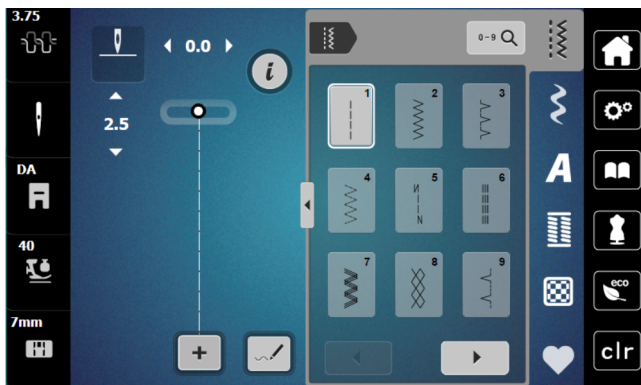

Selecting a Stitch

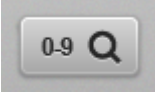
1. Select stitches by touch selection, or by using the Search by Number function. Use your finger or the stylus that came with the machine to access buttons on the screen. 
2. Stitches are grouped into categories with some categories having multiple folders for selection.
3. Many categories have more than one screen.
 - Use the arrows at the bottom of the display to move forward and back in the stitch category.

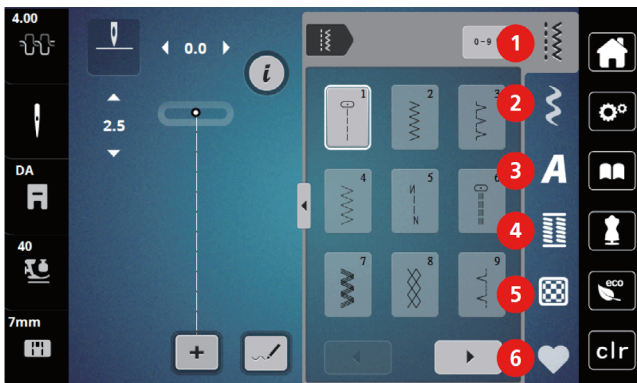

- | | |
|-----------------------|-----------------------------|
| 1 Practical Stitches | 4 Buttonholes |
| 2 Decorative Stitches | 5 Quilt Stitches |
| 3 Alphabets | 6 bernette Personal Program |

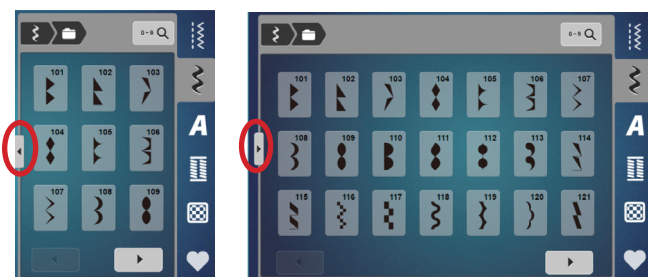

Transitions

1. View more stitches on screen by using the Transition. Select to view all folders or to see more stitches at one time.
2. Select Folder 101. Touch the Transition arrow to view the stitches in the category.
3. Some categories will have more than one screen. Use the arrows at the bottom of the screen or scroll to move forward or backward.
4. Touch the Transition icon to close the screen.

Presser Foot Sole Display

Selecting the Presser Foot Sole Display recommends a sole to be used according to the stitch selected. The recommended sole is denoted with a green check. Other soles that may be used depending on the application will feature a star in the upper right corner. On the b79, touching the sole icon will bring up a display with more information about that particular sole.

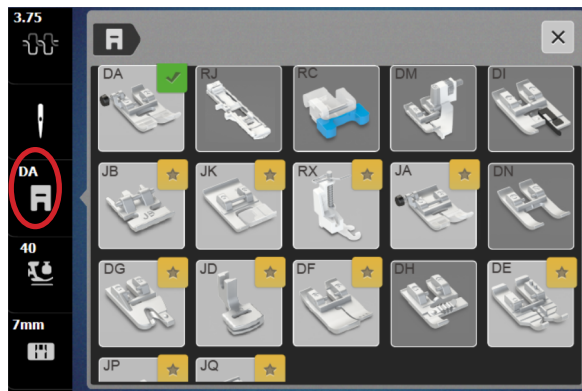

1. Select the Straight Stitch.
2. Select the Presser Foot Sole Display from the Status Bar.
3. Touch Sole DA on the display. On the b79, information about the sole will be displayed.
4. Read the information about the sole.
5. Touch the sole icon in the breadcrumb path at the top of the display.
6. Touch another sole and read the information about the sole and its applications.
7. Close the Presser Foot Sole Selection menu.

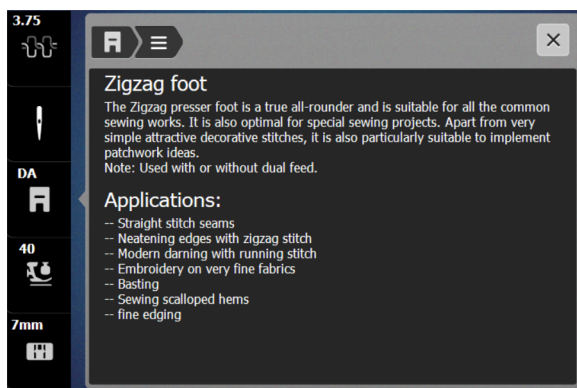

Notes:

- *The Presser Foot Sole Display on the b79 and b77 give suggested soles for certain stitches, but this is for informational purposes only. It does not limit the stitch properties.*

Security Program-Needle

Setting the Needle Security Program can be very helpful in sewing. It can prevent needle breakage and damage to your machine or presser foot. The function remains active even when the machine is turned off and on.

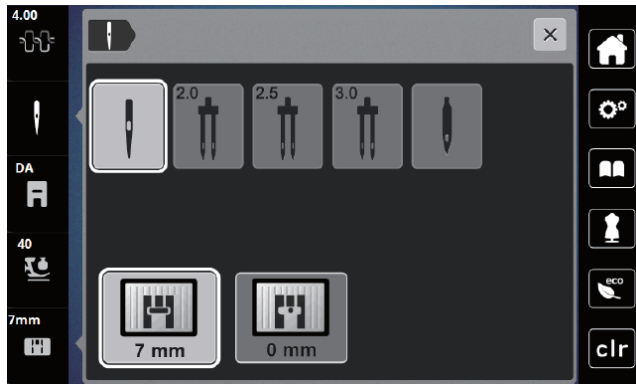

For more information on needles, refer to Reference-Sewing Machine Needles on Pages 37 and 38.

1. Touch the Needle Selection icon. A display will appear.
2. Select the Standard Needle.

Specialty Needles: When selecting a specialty needle (such as a twin needle), it can be checked whether or not it can be used in combination with the attached stitch plate. If the needle is suitable with the attached stitch plate, sewing can be started. If the selected needle does not match the stitch plate, a red exclamation will appear on the display.

Sew HOW

Do you know:

- On the b79 and b77, the **bernette Creative Consultant** recommends the needle according to the fabric and technique.



Security Program-Stitch Plate Selection

The b79 and b77 have a built-in sensor that detects which stitch plate is attached. If an inappropriate needle or stitch is selected, the machine will limit the width of any stitch to prevent needle breakage. The function remains active even when the machine is turned off and on.

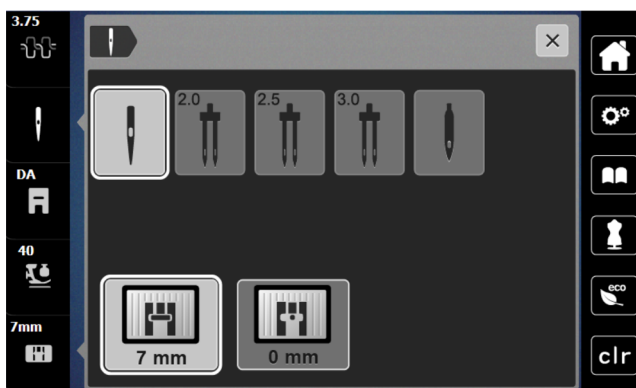
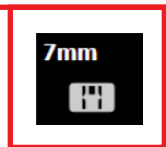

1. Touch the Stitch Plate Selection icon.
2. The machine automatically detects which stitch plate is attached.

0 mm: This plate is used for embroidery. Many quilters prefer to use this stitch plate when piecing. This is also the plate to use when using the CutWork Tool. (The 0 mm Stitch Plate is an optional accessory for the b77.)

The 'i' menu

All creative functions that can be applied to a stitch are accessed through the Information ("i") menu.



1. Select Stitch #102.
2. Touch the "i" to access the Information menu.
 - Only icons relevant to the selected stitch are visible.
 - A different set of icons is available for practical stitches, decorative stitches, alphabets, quilting stitches or buttonholes.
 - When making multiple alterations within the "i" menu, use breadcrumb navigation to stay within the "i" menu until all changes have been set before closing.
 - Select the "i" in the breadcrumb path to go back one level.
3. Touch the stitch number in the breadcrumb path to return to the stitch selection menu.

bernette Dual Feed

The Dual Feed feeds the fabric from above and from beneath simultaneously. This provides an even and careful feed forward even for smooth and thin materials. Striped and checkered patterns can be matched perfectly by even feeding. Use only presser feet with the back opening when engaging the Dual Feed mechanism.

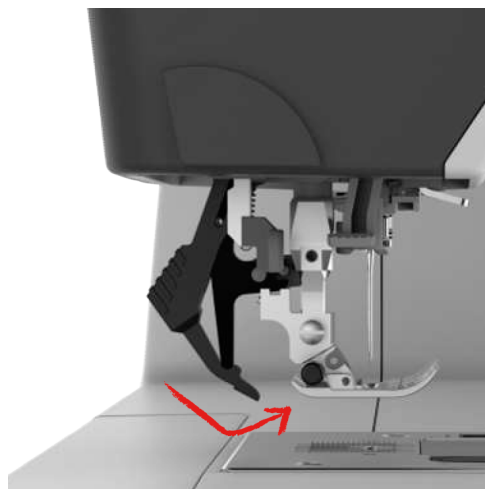





To engage dual feed:

1. Attach Zigzag Sole (DA).
2. Raise the presser foot.
3. Swing the Dual Feed mechanism forward under the back of the presser foot until it clicks in position.

To disengage dual feed:

1. Raise the presser foot.
2. Pull down the Dual Feed mechanism and swing it to the rear to disengage.

Needle Stop Up/Down-bernette Free Hand System

-  Firm woven fabric, 4" x 6", two pieces
-  80/12 Universal
-  Polyester or cotton embroidery thread
-  Center
-  Zigzag Sole (DA)-Dual Feed Engaged

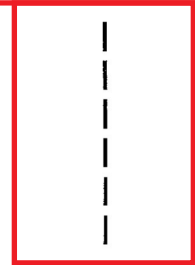

1. Select the Straight Stitch #1.
2. Touch the Needle Up/Down button on the machine. Each push of the button will raise or lower the needle.
3. To program the needle to stop in the down position, select the Needle Stop Up/Down icon on the screen. 
4. Sew a line of stitching and stop in the middle of the fabric. Hover is turned on by default and the foot will raise 2.0 mm when the machine stops.
NOTE: *Hover can be programmed from 1 mm (not raised at all) to 6 mm in height.*
5. Pivot to form at least 2 right angle corners and 2 additional corners.
 - When pivoting, use the bernette Free Hand System Knee Lfter to raise the presser foot.

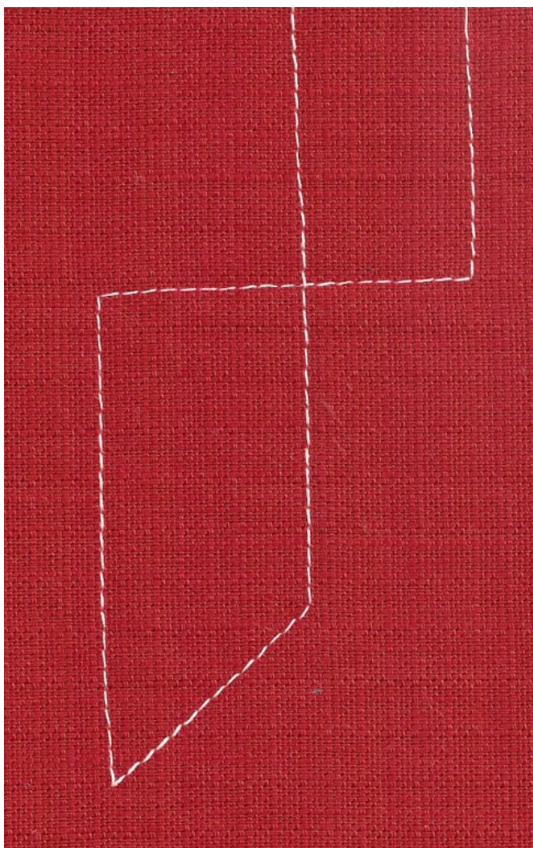

How do I lower the presser foot for sewing?





- There is no presser foot lift in the back of the machine--use the button on the front of the machine to raise/lower the presser foot.
- Press the Foot Control to lower the foot and begin sewing.
- Press/tap the Start/Stop button to hover and re-position your work as needed.

Sew HOW

Do you know how to:

- Use the bernette Free Hand System?
- Use the back-kick on the bernette Foot Control to move the needle up or down?

Securing Stitches

-  Firm fabric, 4" x 6", three pieces; fold in half lengthwise to 2" x 6"
-  80/12 Universal
-  Polyester or cotton embroidery thread
-  Center
-  Zigzag Sole (DA)-Dual Feed Engaged

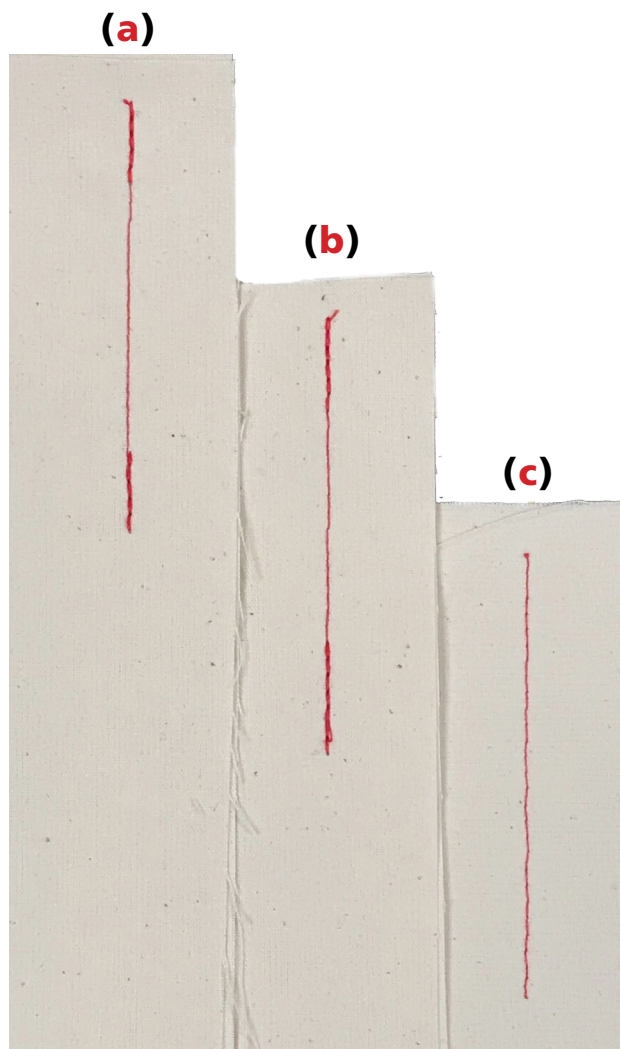
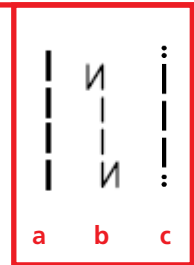

Straight Stitch/Reverse (a)

1. Place one fabric piece under the presser foot, aligning the 6" cut edge with the 5/8" guide line on the stitch plate.
2. Select the straight stitch. Sew a few stitches forward, then press and hold the Quick Reverse Button on the machine as you sew a few stitches backward; the machine will sew in reverse until the Quick Reverse Button is released.
3. Continue stitching the seam; secure the end in the same way.

Securing Program (b)

1. Select the Securing Program #5. Begin to sew on 2nd piece of fabric; the machine will automatically take six straight stitches forward and back at the beginning to secure the stitching.
2. At the end of the seam while the machine is still stitching, press and release the  Securing button. The machine will automatically take five stitches backward, five stitches forward to secure the stitching, and then stop.

Quilter's Securing Program (c)







1. Select the Quilting Securing Program #1001. Begin to sew on 3rd piece of fabric; the machine will take 5 short stitches forward automatically when sewing is started. Then continue stitching forward.
2. At the end of the seam, press and release the  the Securing button. The machine will take 5 short stitches forward to secure and then stop.

Sew HOW

Do you know how to:

- Activate the Securing Function at the beginning and end of a stitching pattern?

Permanent Reverse/Backstepping

-  Firm woven fabric, 4" x 6"
-  Lightweight tear-away stabilizer 4" x 6"
-  80/12 Universal
-  Polyester or cotton embroidery thread
-  Default
-  Zigzag Sole (DA)-Dual Feed Engaged

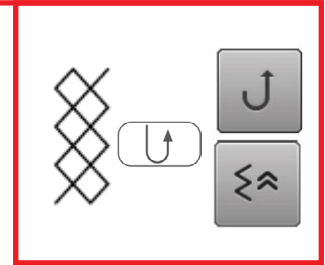

NOTE:

- The Quick Reverse button on the machine can be programmed in the setup menu to operate as Quick Reverse or Backstepping.



Permanent (Continuous) Reverse sews the selected stitch pattern in reverse.

Backstepping is more precise, as it will retrace the last 200 needle penetrations to give accurate stitch-by-stitch reverse sewing.

This feature is great when you have a thread break or unknowingly run out of bobbin thread. You can re-thread and backstep to the exact location of the last sewn stitch.







1. Place the stabilizer behind the fabric.
2. Select the Honeycomb Stitch #8. Engage the Needle Stop Down function.
3. Stitch about two inches on the fabric and stop with the needle down; do not move the fabric.
4. Select the "i" menu. From this menu, you can select Permanent/Continuous Reverse or Backstepping:
 - Permanent Reverse can be accessed either with the button on the machine, or by selecting "i"; Permanent Reverse Sewing.
 - Backstepping can be accessed by selecting "i"; Backstepping.
 - Backstepping can also be accessed with the button on the machine, depending on the setting.
5. Touch the Backstepping icon and continue stitching; the machine will now stitch backward, forming the stitches precisely on top of the previous ones.
6. Clip threads. Select the Backstepping icon again to disengage the function.

Sew HOW

Do you know how to:

- Sew backward on your model?

Mirror Image/Pattern Repeat

-  Firm woven fabric, 4" x 6"
-  Lightweight tear-away stabilizer 4" x 6"
-  80/12 Universal
-  Polyester or cotton embroidery thread
-  Default
-  Embroidery Sole-Sewing (JK)



1. Attach Embroidery Sole JK.
2. Place stabilizer behind fabric.

Left/Right Mirror Image:

1. Select Blanket Stitch #1008 from the Quilting Stitches menu.
2. Sew one row down length of fabric.
3. Engage Mirror Image Left/Right and sew a second row next to the first, using the side of the presser foot for spacing.

Pattern Repeat:

1. Select Stitch #113.
2. Select the "i". Change Pattern Repeat to 4x.

Up/Down Mirror Image:

1. Stitch one stitch pattern for a total of 4 paisleys. The machine will stop when the stitch pattern is complete.

Tip: To make sure you have a complete pattern, depress the foot control and do not lift your foot until the machine stops.
2. Engage Mirror Image Up/Down. The entire stitch pattern of four paisleys will be mirror imaged.
3. Stitch one stitch pattern for a total of four paisleys.

Horizontal Mirror Image (Left/Right):

- Machine sews selected stitch in Horizontal Mirror Image.
- Right/left is determined by the sewing direction.

Vertical Mirror Image (Up/Down):

- Machine sews selected stitch in Vertical Mirror Image.
- Up/down is determined by the sewing direction.

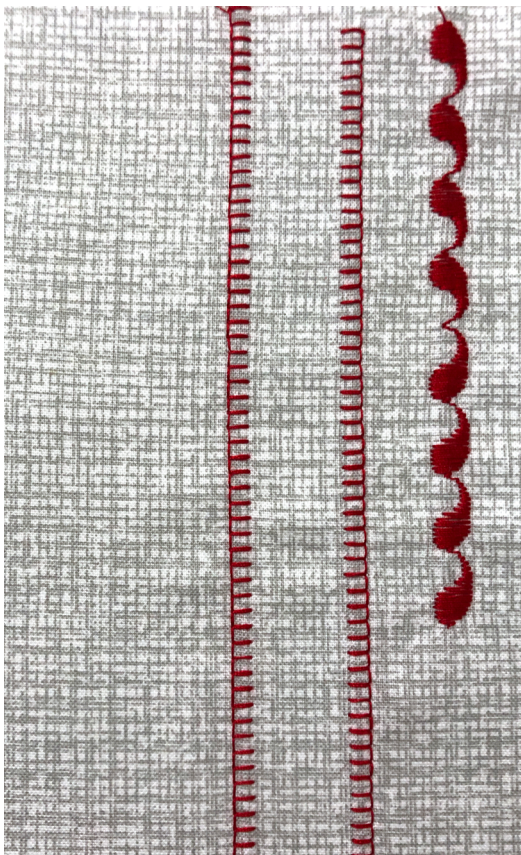







Sew HOW

Do you know how to:

- Tell the difference between Mirror Image Left/Right and Up/Down functions?
- Engage Pattern Repeat?

Pattern Functions - Pattern Begin/End

-  Firm woven fabric, 4" x 6"
-  Lightweight tear-away stabilizer 4" x 6"
-  80/12 Universal
-  Polyester or cotton embroidery thread
-  Default
-  Embroidery Sole-Sewing (JK)

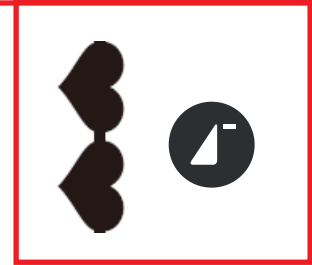

NOTE: Refer to Page 40 Reference-Decorative Stitching for more tips on appropriate tools for decorative stitching.

Tip: To make sure you have a complete pattern, depress the foot control and do not lift your foot until the machine stops.



1. Place stabilizer behind the fabric.
2. Select the satin stitch hearts-Stitch #124.
3. Select the Presser Foot Sole Display. Notice the Sole JK is the recommended foot. Attach Embroidery Sole JK.
4. Sew 2½ patterns, stopping in the middle of the third pattern.
5. Lift the presser foot and move the fabric down about an inch; then begin sewing again. The pattern will start forming where you left off.
6. After completing the interrupted heart, start the final heart and press the Securing Button. The machine will stop stitching when the pattern is complete. **NOTE:** The Securing Button was programmed to complete a stitch pattern when pressed. (See Page 6 Programming Securing Button.) 
7. Move to a new position and sew 2½ patterns, stopping in the middle of the third pattern. Lift the presser foot and move the fabric down about an inch.
8. Before starting to sew again, press Pattern Begin.

NOTE: The Pattern Begin icon appears on the screen in the stitch altering area only when the pattern is not at the beginning. To get to the beginning of the pattern, select the on-screen Pattern Begin icon. If it is not visible, then the needle is at the beginning of the stitch pattern.

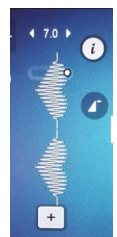







9. Start sewing; the pattern will start forming at the beginning. Again, press the Securing Button when you start stitching the final heart.

Sew HOW

- Do you know how to:**
- Access Pattern Begin?

Pattern Functions-Pattern Repeat/Extend

-  Firm woven fabric, 4" x 6"
-  Lightweight tear away stabilizer 4" x 6"
-  80/12 Universal
-  Polyester or cotton embroidery thread
-  Default
-  Embroidery Sole-Sewing (JK)

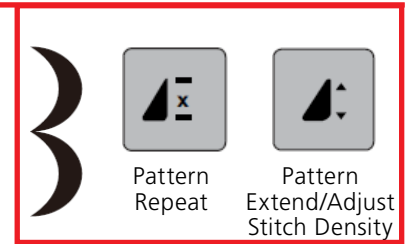

Notes:

- The *Stitch Density* of a stitch can be increased or decreased by using the *-/+* icons under *Stitch Density*. It can be changed in a decorative application to change the stitch as you prefer, and is most effective with satin stitches (Folder 101). *Stitch Density* is not available for every stitch. 
- *Pattern Extend* allows you to increase or decrease the length of an entire stitch pattern in 100% increments without changing the stitch density. This feature is not available for every stitch.



Pattern Repeat 1-9x

Program the b79 and b77 machines to stop at the end of 1 - 9 repeats of a single stitch or stitch combination.

1. Attach Embroidery Sole JK
2. Place the stabilizer behind the fabric.
3. Select the satin stitch scallop-Stitch #108; Open the "i" menu and change Pattern Repeat to 1x.
4. Sew until the machine stops; you will have one scallop.
5. Increase Pattern Repeat to 3x. Sew until the machine stops; you will have one stitch pattern.

NOTE: In this case, one stitch pattern equals the repeated group of three scallops.

Pattern Extend







1. Change Pattern Repeat to 1x.
2. Select the Pattern Extend/Adjust Stitch Density icon.
3. Set Pattern Extend to 300% using the slider icon (or *-/+*).
4. Sew until the machine stops; you will have one stitch pattern.
 - In this case, one stitch pattern equals one extended scallop.
 - As the stitch pattern is elongated (stretched), the stitch density is maintained.
5. Select the "i" in the breadcrumb path to close the Pattern Extend display and return to the "i" menu.

Sew HOW

Do you know how to:

- Recognize the two different pattern functions (which icon stands for each)?

Altered Stitches

-  Firm woven fabric, 4" x 6"
-  Lightweight tear-away stabilizer 4" x 6"
-  80/12 Universal
-  Polyester or cotton embroidery thread
-  Default
-  Embroidery Sole-Sewing (JK)

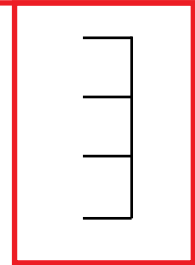

Row 1	Row 2	Row 3
Programmed settings	4 mm width 3 mm length	4 mm width Default length

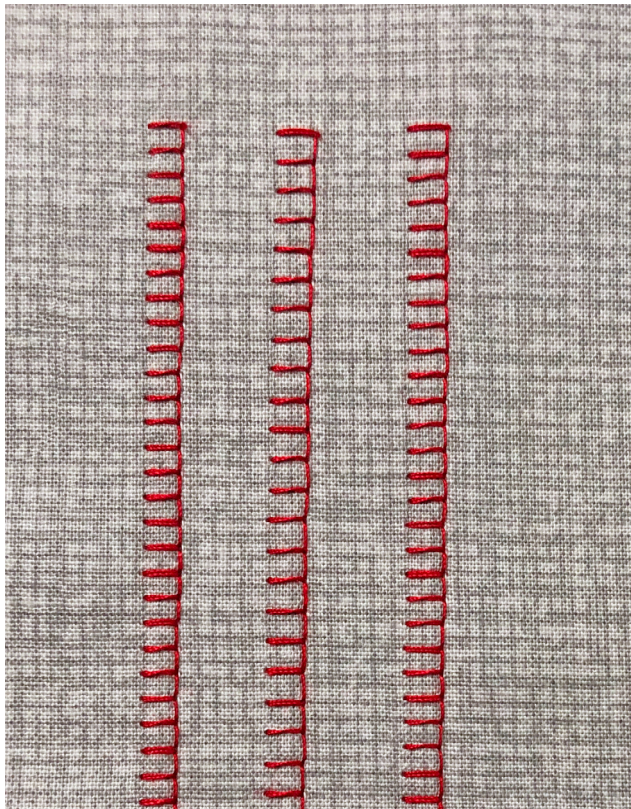

1. Attach Embroidery Sole JK.
2. Place the stabilizer behind the fabric.
3. Select Blanket Stitch #1008 from the Quilting Stitches menu.
4. Sew a row of stitches. (Row 1)
5. Adjust stitch width to 4 mm and stitch length to 3mm. Sew a second row of stitching next to the first. (Row 2)
6. Touch the stitch length numeric value on screen. Tap the yellow highlighted box to revert the stitch length to the machine default stitch length setting of 2.5. Leave the stitch width at 4.0 mm.
7. Sew a third row of stitching next to the previously sewn rows. (Row 3)
8. Leave this stitch on the screen and go to the next page.

Sew HOW

Do you know how to:

- Find the Quilting Stitch menus on your model?
- Reset the stitch length and width to the preprogrammed settings?

Temporary Altered Memory

The bernette 79 and bernette 77 have Temporary Altered Memory. The machine will remember the last stitch alterations made to any stitch. These alterations will remain in effect until manually changed, until CLR is touched, or until the power to the machine is turned off.

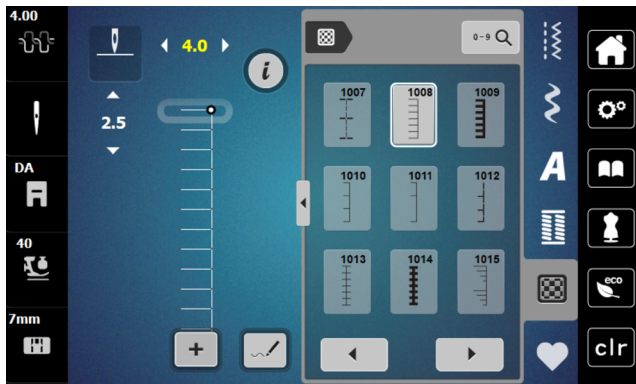

1. Using the stitch created on the previous page, notice that the stitch width has been changed. This is indicated by the yellow number.
2. Select Stitch #1.
3. Re-select Blanket Stitch #1008 from the Quilting Stitches menu. Notice that the stitch has retained the altered settings.
4. Leave the width at the altered setting.

Saving Stitches in bernette Personal Program

Use the bernette Personal Program to store your favorite stitches, most often used stitches, or perhaps a group of stitches needed for a particular technique or project.

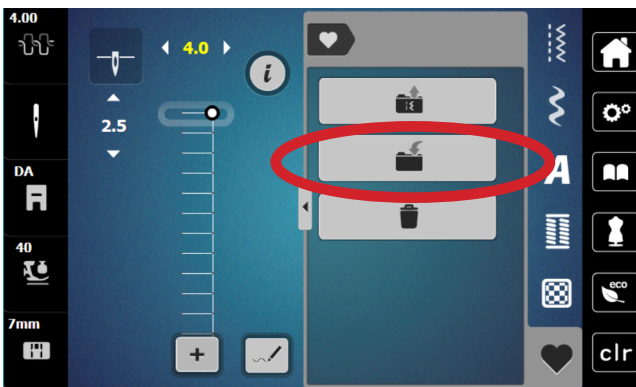





Creating a Personal Program

1. Select the desired stitch. For this exercise, select the altered Blanket Stitch from previous page.
2. Close the "i" display, if opened.
3. Touch Personal Program.
4. Select the Save to Personal Program (folder with arrow going in) icon.
5. The selected stitch has a yellow border around it. Select the highlighted stitch to save, or select the green check box with the check to add the stitch to the Personal Program folder.
6. The display closes.



Triple Straight Stitch

-  Firm woven fabric, 4" x 6", two pieces
-  80/12 Universal
-  Polyester or cotton embroidery thread
-  As directed in instructions
-  Zigzag Sole (DA)-Dual Feed Engaged

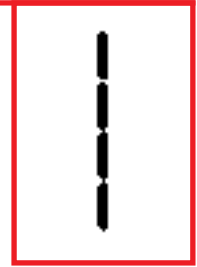

Notes:

The Triple Straight Stitch creates a very sturdy seam on items that will receive a lot of wear.

It also creates beautiful bold topstitching with regular weight thread that mimics the look of a heavier decorative topstitching thread.

1st Line 2nd Line



Triple Straight Stitch Seam

The triple straight stitch is optimal for reinforced seams in heavy fabrics.

1. Attach Zigzag Sole DA to the machine and engage the Dual Feed Mechanism.
2. Select the Triple Straight Stitch #6.
3. Place the fabric pieces right sides together.
4. Position the edge of the fabric along the 5/8" mark on the stitch plate.
5. Sew the seam and press it open.

Triple Straight Stitch Edgestitching





1. Adjust the needle position to the far right.
2. With the right side of the fabric up, place the right edge of the foot along the ditch of the seam. Sew the length of the seam from top to bottom (1st Line).
3. Adjust the needle position to the far left.
4. Stitch a second time with left side of the foot along the ditch of the seam. Sew in the same direction as before (2nd Line).

Sew HOW

Do you know how to:

- Adjust the needle position?
- Adjust the stitch length?

Vari-Overlock Stitch

-  Cotton interlock, 4" x 6", two pieces
-  80/12 Universal
(Ballpoint or Stretch may also be used)
-  Polyester or cotton embroidery thread
-  As programmed
-  Overlock Sole (DI)-Dual Feed Engaged

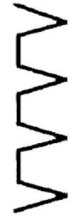

1. Attach Overlock Sole DI to the machine and engage the Dual Feed Mechanism.
2. Select the Vari-Overlock Stitch #3.
3. Engage the Needle Stop Down function..
4. Guide the raw edges of the fabric against the black guide on the foot and stitch the two layers together. The stitch will form over the pin and the edge of the fabric.

Notes:

Using the Overlock Foot and the Vari-Overlock Stitch will keep the edge of the fabric flat, not rolled.

This can be used as a seam finish on wovens, or as an actual seam on knit fabrics.

Other stitches that work with this presser foot are the Stretch Overlock Stitch and the Double Overlock Stitch.

When you select this stitch, and then select Presser Foot Sole Display, the Overlock Sole DI will be displayed with a green check indicating that it is the recommended presser foot for the stitch.

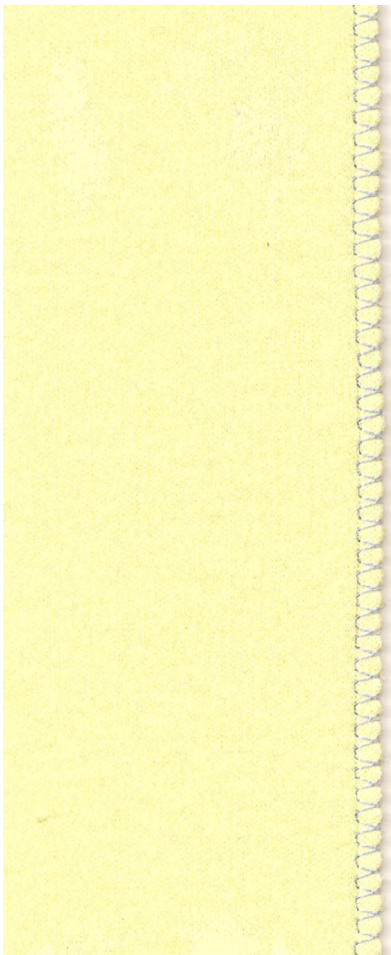





Sew HOW

Do you know how to:

- Engage the Needle Stop Down feature?
- Position Overlock Foot on the fabric?

Basting

-  Wool-like fabric or Heavy flannel, 8" x 6"
-  80/12 Universal
-  Polyester or cotton sewing thread
-  Default
-  Zigzag Sole (DA)-Dual Feed Engaged



NOTE: This fabric sample will be used with the Blind Hem Exercise on the following page.

Optional: Finish one 6" edge of the fabric with a zigzag stitch, the Vari-Overlock Stitch, or an overlock machine.

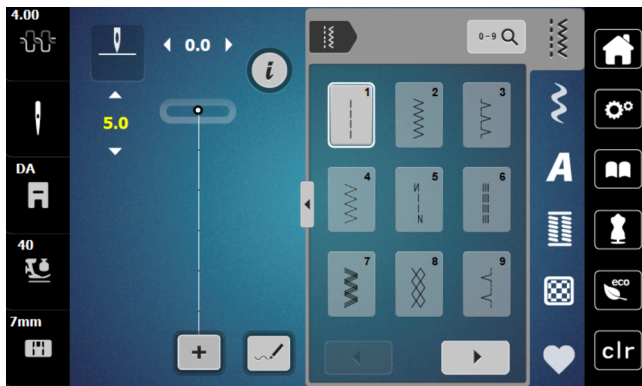





1. Fold a 2" hem to the wrong side of the fabric and press.
2. Select the straight stitch. Touch clr to clear any previous changes to the stitch.
 - Increase the stitch length to 5 mm. Notice the stitch length appears longer on the display giving you a visual of how the stitch will look.
3. Baste the hem in place, sewing about 3/4" from the raw edge of the hem or optional stitched edge.
4. Press clr to return to a standard straight stitch.
5. Close the "i" display.
6. Use this sample for the Blind Hem exercise on the next page.

Sew HOW

Do you know how to:

- Increase or decrease stitch length?
- Clear stitch width and length independently?

Blind Hem

-  Wool-like fabric or heavy flannel, 8" x 6"
-  80/12 Universal
-  Polyester or cotton sewing thread
-  As programmed
-  Blindstitch Sole (DM)-Dual Feed Engaged

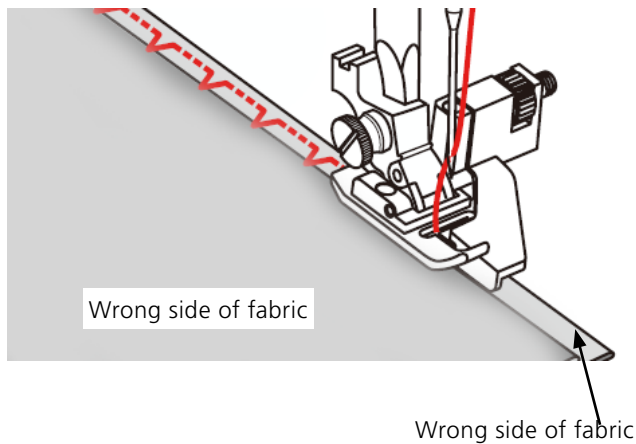
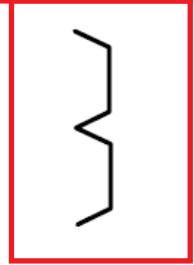

1. Begin with a basted 2" hem as instructed on previous page.
2. Select the Blind Stitch #9.
3. Attach the Blindstitch Sole DM to the machine and engage the Dual Feed mechanism.
4. Fold the hem back to the right side over the basting line, exposing the zigzagged edge (or raw edge if not finished) of the fabric.
5. Turn the handwheel forward by hand until the needle swings fully to the left.
 - Adjust the guide (2) by turning the knob (1) so that the guide just rests against the fold.
 - It should just pierce the fold of the fabric. If it does not, adjust the stitch width accordingly.

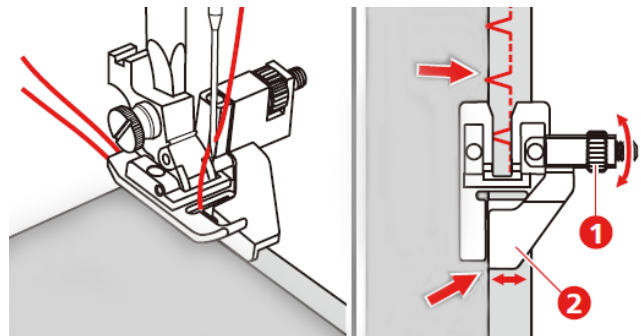





6. Sew on the extended hem allowance, keeping the folded edge next to the guide on the foot.
7. Unfold the fabric when finished, and notice that the stitches barely show on the outside of the fabric.

Sew HOW

Do you know how to:

- Machine baste using a longer stitch length?
- Adjust the Blindstitch Sole to create an invisible hem?

Stretch Stitch

-  Spandex, 4" x 6", two pieces
-  80/12 Universal (Ballpoint or Stretch may also be used)
-  Polyester or cotton sewing thread
-  As programmed
-  Zigzag Sole (DA)-Dual Feed Engaged



1. Attach Zigzag Sole (DA) to the machine and engage the Dual Feed mechanism.
2. Select the Super Stretch Stitch #11.
3. Place the fabric pieces right sides together.
4. Position the edge of the fabric on the 5/8" marking on the stitch plate.
5. Sew the seam.

NOTE: If the fabric is pulling and stretching as it is sewn, adjust the Presser Foot Pressure on screen to a lower number to lighten the pressure of the foot on the fabric and eliminate the stretching.









Sew HOW

Do you know how to:

- Adjust the presser foot pressure?
- What fabric types you would use with this stitch?

Balance

-  Firm woven fabric, 4" x 6"
-  Lightweight tear-away stabilizer 4" x 6"
-  80/12 Universal
-  Polyester or cotton embroidery thread
-  Default
-  Embroidery Sole-Sewing (JK)

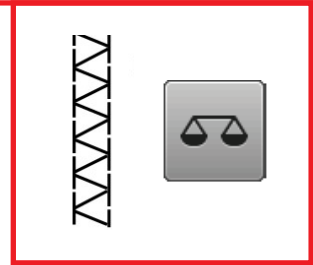

Notes:

The Balance function is generally reserved for fine tuning the stitch appearance, but is sometimes required because of differences in fabrics and threads.

The Balance Function is used to troubleshoot and fine tune stitches if they do not produce desired results with default settings. Most often, this is caused by unusual fabrics or threads.

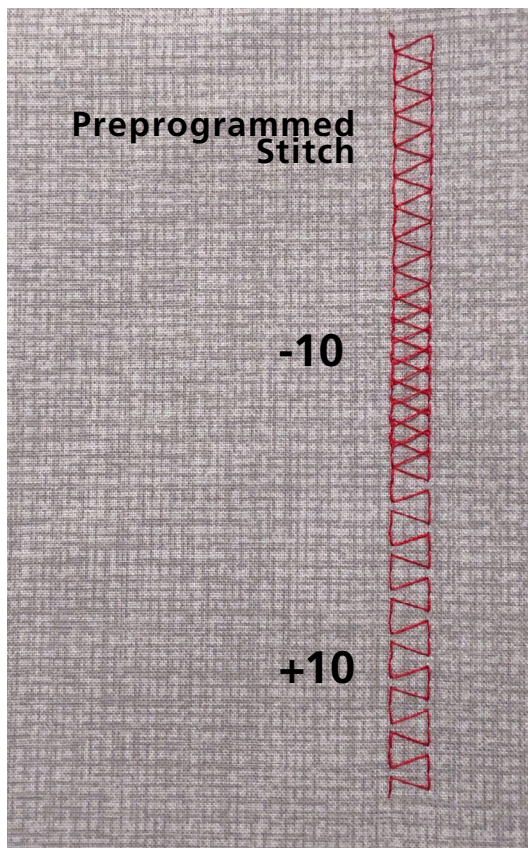

1. Attach Embroidery Sole (JK)
2. Place the stabilizer behind the fabric.
3. Select the Double Overlock Stitch #10, and sew for about 1 1/2".
4. Select the 'i' icon and select Balance; the right side of display shows stitch pattern as programmed.









5. Use the Lower Multi-function (Stitch Length) knob or the lower - icon to adjust the stitch -10; stitch for another 1 1/2".
6. Use the Lower Multi-function (Stitch Length) knob or the lower + icon to adjust the stitch +10; stitch for another 1 1/2".
7. CLR returns the stitch to default settings.

Sew HOW

Do you know how to:

- Fine-tune the stitch balance on your machine?

Automatic Buttonhole

-  Wool-like fabric or heavy flannel, 8" x 6"
-  Lightweight tear-away stabilizer 4" x 6"
-  80/12 Universal
-  Polyester or cotton embroidery thread
-  As programmed
-  Buttonhole Sole with Slide (RJ)
-  3/4" (19 mm/30L) two-hole button

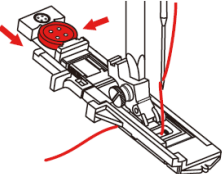

1. Fold the fabric square in half to 3" x 6". Press.
2. Mark the start positions for two buttonholes on the fabric. (The maximum buttonhole length is 3 cm (1 3/16") which is the total of the diameter plus the thickness of the button.) The length of the buttonhole will be determined by the button inserted in the buttonholer plate. 
3. Insert the stabilizer between the layers.

4. Pull out the button holder plate and insert the button. Pass the thread through the hole in the presser foot; then place the thread under the foot. 
5. Attach Buttonhole Sole with Slide (RJ).
6. Select the Buttonhole menu; select Standard Buttonhole #51.

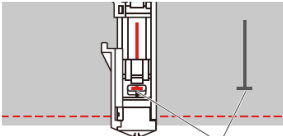
7. Adjust the stitch width and length to the desired width and density.
8. Position the fabric under the presser foot so that the drawn center line is aligned with the center of the buttonhole foot (1). 

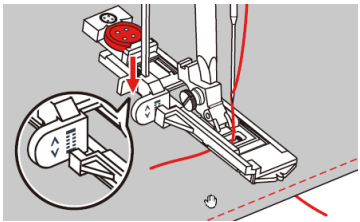
9. Push the Start/Stop button. While the buttonhole lever is raised, an error message will be displayed to remind you to lower the buttonhole lever. Pull down the buttonhole lever as far as possible until it clicks into place. 









10. Hold the end of the upper thread in your hand and start sewing. After the buttonhole has been sewn, the machine sews a securing stitch automatically and then stops.
11. The buttonhole is repeatable without re-setting. Stitch the second buttonhole.

NOTE: We will use this same buttonhole to stitch the corded buttonhole on the next page.



Automatic Buttonhole-Corded



-  Wool-like fabric or heavy flannel, 8" x 6"
-  Lightweight tear-away stabilizer 4" x 6"
-  80/12 Universal
-  Polyester or cotton embroidery thread
-  As programmed
-  Buttonhole Sole with Slide (RJ)
-  3/4" (19 mm/30L) two-hole button
-  18" Narrow cord (perle cotton, embroidery floss, etc.)

Corded Buttonhole

1. The button should still be in the back of the Buttonhole Sole with Slide and the foot attached to the machine.
2. Fold the cord in half, place the loop over the hook at the back of the foot.
3. Bring the two cord ends to the front of the foot and insert them in the grooves at the bottom of the foot. Tie the ends temporarily at the front of the foot.

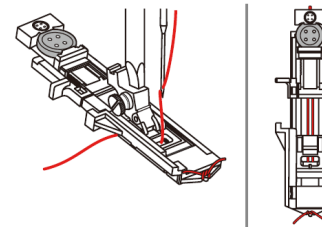

4. Adjust the stitch width and length as desired.
5. Lower the presser foot and sew the buttonhole. The buttonhole will sew over the cord, encasing it within the stitches.
6. Pull the cord through the buttonhole until the loop disappears in the bartack.
7. Pull the ends of the cord through to the wrong side of the fabric using a hand stitching needle; knot or secure with stitches.

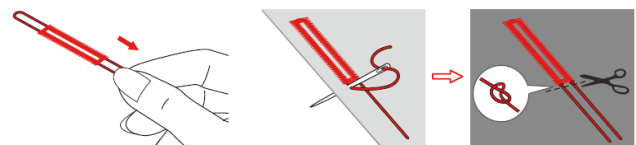



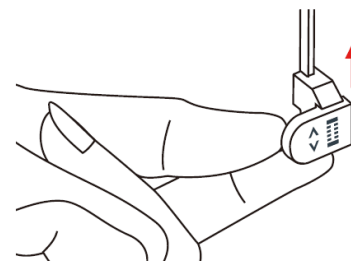





8. Raise the foot and cut the thread
9. After sewing the buttonhole, raise the buttonhole lever until it stops.



Attaching Buttons



-  Firm woven fabric, 4" x 6"
-  Lightweight tear-away stabilizer 4" x 6"
-  80/12 Universal
-  Polyester or cotton embroidery thread
-  As Programmed
-  Button Sew-on Sole (RC)
-  Feed dogs down
-  3/4" (19 mm/30L) two-hole button

Tips:

- A longer shank is appropriate for coat and jacket-weight fabrics. To achieve this, place a darning needle on top of the button between the eyes before stitching the button on.
- Stitch a ribbon with this technique (the stitch makes a bartack) and then tie the ribbon into a bow.



1. Attach the Button Sew-On Sole (RC) to the machine with the blue part of the foot in front.
2. Lower the feed dog.
3. Select the Button Sew-On Program #60.
4. Fold the fabric in half to 4" x 4" and press.
5. Insert the stabilizer between the layers of fabric.
6. Place the button on the fabric.
7. Check the distance between the holes of the button by turning the hand wheel. Adjust the stitch width if necessary so that the left and right swings of the needle fall into the holes of the button. Hold the thread tails as you begin to sew.
8. When using the Button Sew-on Program, the machine stops automatically when the program is complete (keep the Foot Control fully depressed until the machine stops, or use the Start/Stop button).
9. Pull on both bobbin threads until the ends of the upper threads are visible on the wrong side.
10. Knot the ends manually.

Sew HOW

Do you know how to:

- Lower the feed dog on your machine?

bernette Creative Consultant

The bernette Creative Consultant provides information and help with various sewing techniques, including zippers. After selecting the fabric and the desired sewing technique, suggestions for suitable needle, presser foot, etc. are displayed.



1. Touch the Creative Consultant icon.
2. Select the Medium-weight icon (top row, second column) and the Sewing Techniques display will open.
3. Choosing the desired sewing technique:
 - Select the Zipper icon. Recommendations for the selected material and the desired sewing technique are displayed.
 - If the green check is selected, the suggested stitch pattern will appear. Any other changes suggested (stitch length, tension, etc.) will need to be made manually.
 - To close the display without making changes, select the red x box.

Sew HOW

Do you know:

- How to access the bernette Creative Consultant?

Combi Mode-Stitch Patterns

Combi Mode is used to combine alphabets and/or stitch patterns to create new custom stitch patterns. Each combination can hold up to 20 stitches. Stitches can be altered individually using the "i" settings, or the whole combination can be altered. Refer to the machine manual for limitations. Stitch the combination using an appropriate foot for the stitches in the combination. Note: Patterns created in the bernette Stitch Designer (b79) cannot be combined in Combi Mode.



Programming Combi Mode

1. Select the Combi Mode (+ icon at the lower end of the Stitch Altering Area) and the Stitch Altering Area becomes the combination area. As a stitch is selected, it is added to the combination.
2. Select three decorative stitches. Decorative stitches can be added using the Search icon, or by selecting a stitch directly from any Decorative Stitch Folder. The following are suggested stitch combinations: 222, 223, 225.

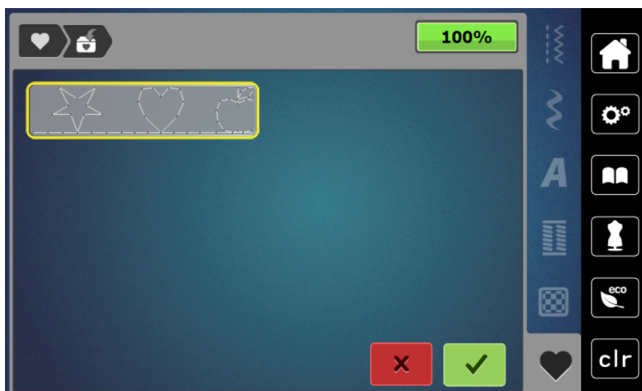

Saving in Memory

1. Select the Personal Program (heart) icon.
2. Select Save (folder with arrow going into it).
3. Touch the highlighted stitch combination or touch Confirm to save.

Deleting Individual Characters

1. Select a single stitch pattern.
2. Select the "i" icon.
3. Touch the Delete (trashcan) icon.

Deleting Combinations on Screen

1. Select the "i" button; select the Edit Complete Combination icon.
2. Touch the Delete (trashcan) icon.
3. Touch the green check box to confirm.









Retrieving Stored Memory

1. Open Combi Mode.
2. Select Personal Memory; select the Combination Folder.
3. Select the desired combination.



Combi Mode-Lettering

-  Firm woven fabric, 4" x 6"
-  Lightweight tear-away stabilizer 4" x 6"
-  80/12 Universal
-  Polyester or cotton embroidery thread
-  Default
-  Embroidery Sole-Sewing (JK)

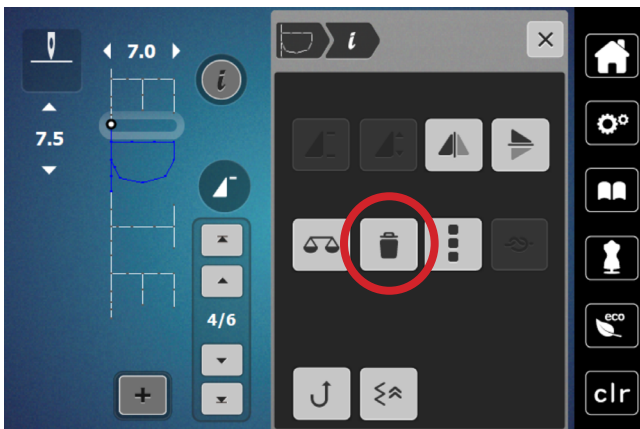

Stitching a word combination:

1. Close the Transition window.
2. Open the "i" menu; select Edit the Complete Combination. Then touch Pattern Repeat 1x and stitch the design.
3. Save the combination using the instructions on Page 19 for accessing and programming the memory.

1. Attach Embroidery Sole-Sewing (JK).
2. Place the stabilizer behind the fabric.
3. Open Combi Mode. (If a previous combination is on the screen, delete the combination. See previous page for directions.)
4. Select the Alphabet menu and select the first alphabet.
5. Program CREDTE (purposely misspelled).
6. To edit:
 - The cursor is the dot. Select the incorrect letter "D" in the list using the arrows. (You can also touch the incorrect letter directly on the display.) Select the Information icon; touch the Delete (trashcan) icon. Close the display.
 - To insert the "A", select the letter *before* the insertion point ("E" in this example) and type the "A". The insertion happens after the cursor.

Using the Transition window to enter and edit text

1. Open Combi Mode. (If a previous combination is on the screen, delete the combination. See previous page for directions.)
2. Select the Alphabet menu and select the first alphabet.
3. Touch the Transition icon to open the Transition Window and type in CREDTE (purposely misspelled).
4. To edit in the Transition view:
 - Touch the incorrect "D" and select the Delete icon to the right.
 - To insert the "A", select the letter before the insertion point ("E" in this example) and type the "A" to spell the word CREATE.
 - Select Transition icon to close the display.

Free-Motion Stitching

 **Two 12" x 12" pieces medium weight cotton**
One 12" x 12" piece low-loft cotton batting

 **80/12 Quilting needle**

 **40 weight quilting thread in needle**
60 wt thread in bobbin

 **Default**

 **Free-motion Embroidery Foot (RX)**

 **Feed dog down**

Free Motion Tips:

- The key to successful free-motion stitching is to run the motor at a consistent speed and move the fabric at a consistent and smooth speed.
- Set the Slide Speed Control to medium and floor the foot control, or use the Start/Stop button on the machine.

Free-motion stitching refers to sewing without the feeding aid of the sewing machine. The feed dog is lowered and the fabric stays in the same place unless you manually move it. Free-motion stitching is used in quilting and thread painting.

1. Make a "quilt sandwich" with the batting between two layers of fabric and practice "drawing" a variety of shapes (see below) on fabric as follows:
2. Using the foot control or the Start/Stop button to run the machine, move the fabric in a forward and back motion.
3. Move fabric from top to bottom; then side to side, keeping the lines of stitching perpendicular to each other. (1)
4. Move fabric to the right, down, to the right, up, to the right, down, to the right, and up. (2)
5. Move the fabric in smooth curves in an up and down motion working from left to right. (3)
6. Move the fabric in loops (4) or figure 8 shapes.
7. Create stippling shapes – think of interconnecting puzzle pieces with evenly sized "bumps." Avoid "painting yourself into a corner" and/or stitching across a previously stitched line. (5)

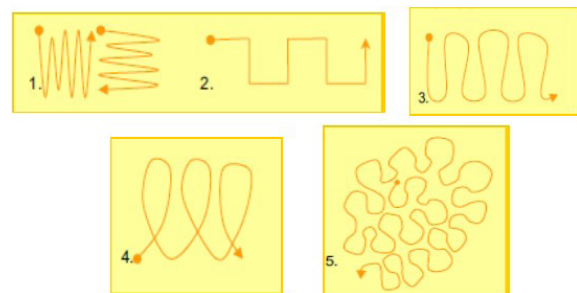

Sew HOW

Do you know how to:

- Lower the feed dogs?
- Move the fabric for even and consistent stitching?

bernette Stitch Designer Overview-b79

b79 only

The bernette Stitch Designer has the ability to create entirely new stitches or to modify existing ones. Stitches can be created by tapping points or free-hand draw with the stylus or fingertip. Variable sizes of stitches are possible.

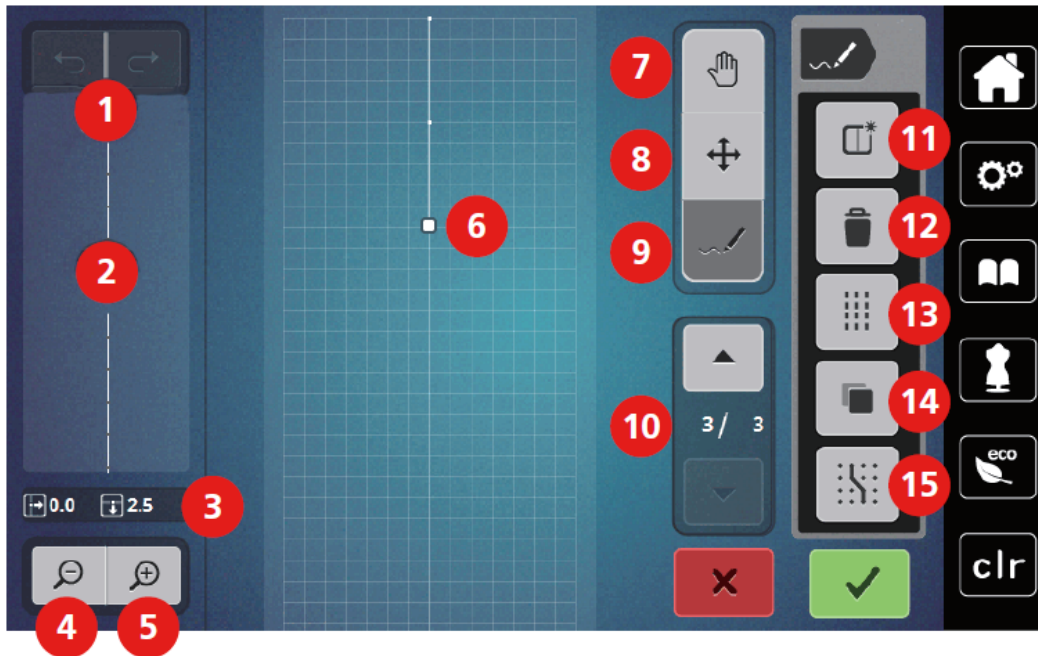



- | | | | |
|---|--|----|-----------------------------|
| 1 | Undo/Redo | 9 | Insert/Edit a Stitch |
| 2 | Preview | 10 | Scroll Through Points |
| 3 | Point Position | 11 | Create a New Stitch Pattern |
| 4 | Zoom Out | 12 | Delete |
| 5 | Zoom In | 13 | Triple Stitch |
| 6 | Stitch Altering Area | 14 | Duplicate |
| 7 | Move View | 15 | Snap to Grid |
| 8 | Move (Relocate Points/
Select Points) | | |

bernette Stitch Designer Tips

- 200 levels of UNDO.
- Created patterns are limited to 200 stitches each.
- Each grid equals 0.5 mm.
- The slightly brighter white line in the middle of the Stitch Designer drawing area represents the center needle position.
- Use Snap to Grid for precise placement.
- Created stitches are sewn only from the sew out display after confirming with the green check in Stitch Designer.
- Created stitches can be saved to the machine memory through Personal Program, but cannot be used in Combi Mode.
- Maximum stitch width is 7 mm.



bernette Stitch Designer - b79 Only

Creating New Stitches-Free-hand Drawing

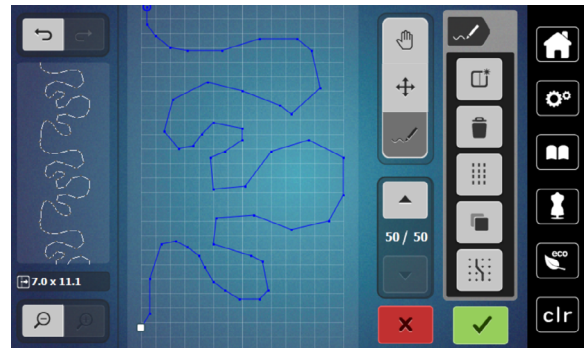
1. Select the bernette Stitch Designer icon from the bottom right of the sewing display. 
2. Touch the Create a New Stitch Pattern icon to get a fresh page. Insert/Edit a Stitch (pencil icon) is the default when entering Stitch Designer. 
3. With your fingertip or stylus, free-hand draw on the screen to fill the 7 mm boundary. Begin and end on the same or approximate vertical grid line for a seamless look.
4. Select Undo/Redo until pleased with the stitch.
5. To start with a fresh screen, touch the Create a New Stitch Pattern icon.



Creating New Stitch Patterns

1. Touch the Create a New Stitch Pattern icon to start another stitch. 
2. Select Snap to Grid icon. Snap to Grid makes it easy to align points as stitch points will only fall on a dot (note the grid changed to dots). 
3. Select Insert/Edit a Stitch Pattern.
4. Design stitch by setting points:
 - Click 1: to begin click at the upper left corner of screen
 - Click 2: diagonal line 8 grids down and 8 grids over
 - Click 3: straight line 7 grids up
 - Click 4: diagonal line 6 grids down and 6 grids to left
 - Click 5: straight line 6 grids to the right.

The way the design will stitch out will appear in the Preview window.
5. Use the up arrow in the Scrolling Through Points section until the last 3 stitches are selected.
6. Disengage Snap to Grid.
7. Select Duplicate; the duplicate is on top of the pattern.
8. Select Move; drag the duplicate down and to the right using your fingers or stylus, or by using the Multi-function knobs.
9. With the triangle still selected, select Duplicate again.
10. Move this triangle to the right and below the others using drag and drop or the Multi-function knobs.

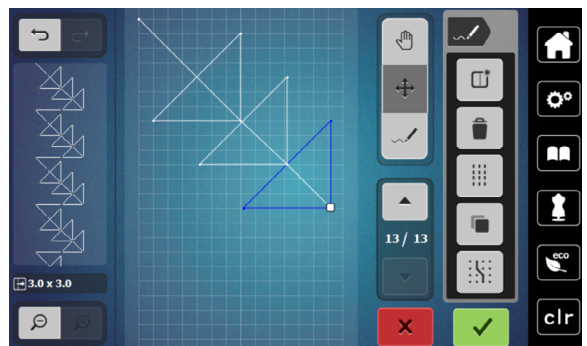
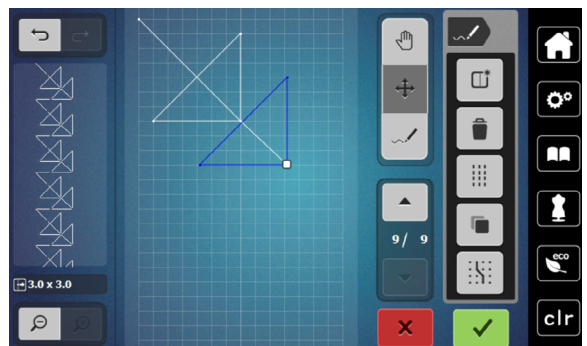
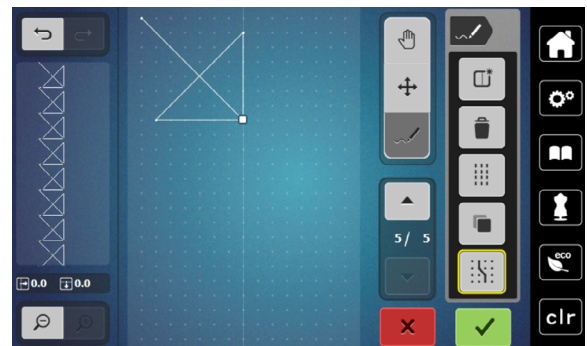

Notes:

The Delete icon (Trash Can) deletes whatever is selected indicated by the blue selection. This can be a single point, a group of points or the entire stitch.



bernette Stitch Designer - b79 Only

Edit and Stitch the New Stitch Pattern

1. Select the Confirm icon to return to the Sewing display. The stitch will appear in the Stitch Altering Area. You can stitch the design as is, or edit the design using features in the Information menu.
2. If you wish to edit the stitch, select the Information icon and make the desired changes.

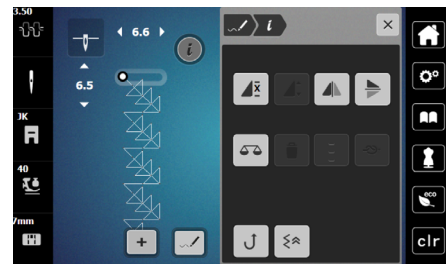

Save the New Stitch to bernette Personal Program

1. To save the custom stitch pattern, close the Information menu (if open), and select the Personal Program icon.
2. Select the Save icon (folder with arrow pointing inward).
3. Save the stitch by touching the new stitch (outlined in yellow), or by touching the green Confirm icon.

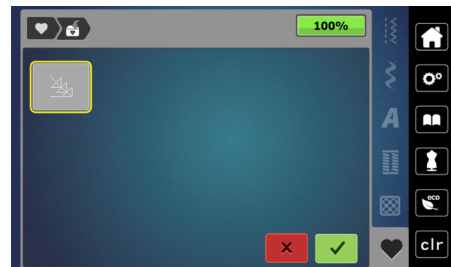
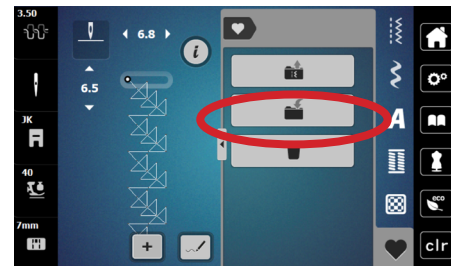

Change a Single Stitch to a Triple Stitch

1. From the sewing display, select any single stitch design (use #223 for this exercise).
2. Select the Stitch Designer icon.
3. Use the up arrow in Scroll Through Points to select the entire design. (It will turn blue.)
4. Select the Triple Stitch icon. The stitch is now a triple stitch design.
5. Select the green check box to return to the Sewing Display; sew out or save to the bernette Personal Program.

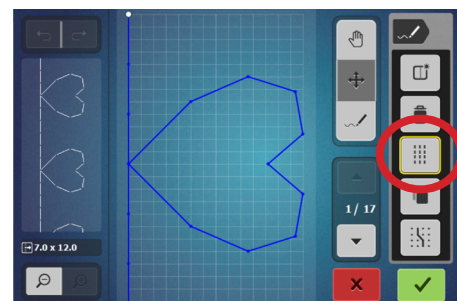
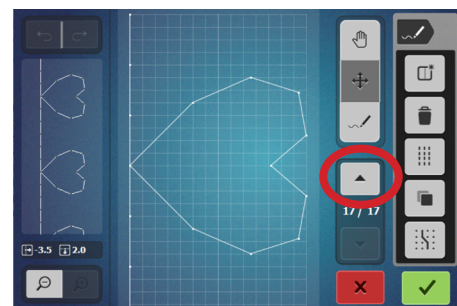

bernette Stitch Designer - b79 Only

Editing an Existing Stitch

1. From the Sewing display, select stitch #191.
2. Select the Stitch Designer icon.
3. Engage Snap to Grid.
4. To move through a design, locate the current stitch point (indicated by the largest dot, and exact stitch number is noted in Scroll Through Points section).
5. The up and down arrows allow you to move through the stitch pattern point by point. Touch the up arrow to move to position 8 / 13.
6. Engage the Move icon and drag the point to the outer boundary on the screen.
7. Touch the center right stitch (7 / 13) point directly on the screen. Move this stitch point to the outer boundary of the screen.
8. Touch the lower right point on the design (6 / 13).
9. Drag the point to the outer boundary on the screen.

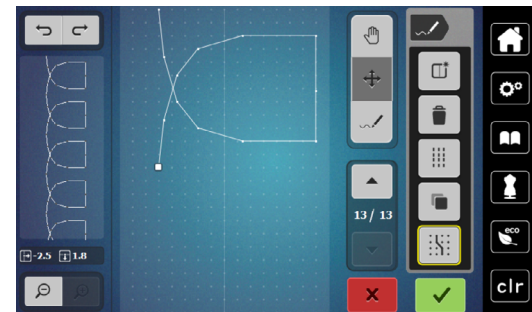
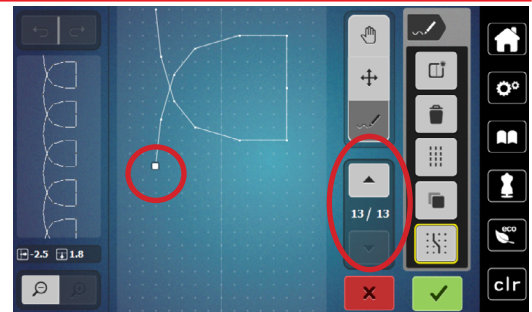

Adding a Stitch Point

1. Select Move and touch the stitch point just before the position you would like to add a new stitch point. For today, this will be stitch 6/13. (Or use the Up/Down arrows to scroll to the stitch point just before the position you would like to add the new stitch point.)
2. Select the Insert/Edit a Stitch (pencil) icon and tap two dots up from this point.
 - A new large dot appears indicating the location of the new stitch point and the stitch count has changed (7/14).
 - If the dot does not go where you want it to, touch the Undo icon to remove it.
3. Select Move icon; drag the point in 4 dots in toward the center.
4. With Move still selected, touch the center right stitch point.
5. Select the Insert/Edit a Stitch icon; touch the screen two dots up from the center point.
6. Select the Move icon and move the new stitch point 4 dots in toward the center.
7. Touch Confirm to return to the Sewing display; sew out or save to the bernette Personal Program.

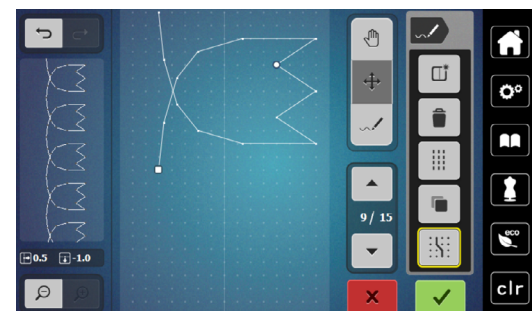
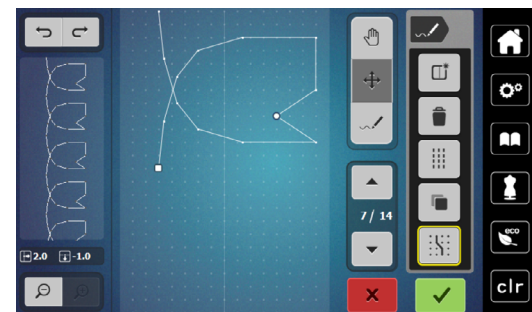

Reference - Sewing Machine Needles

Needle "Secret" Code

- DRI = Triple
- E = Embroidery
- J = Jeans
- L, LL, R = Leather
- M = Microtex
- MET = Metallic
- N = Topstitching/
Cordonnet
- Q = Quilting
- S = Stretch
- SUK = Fine Ball Point
- SES = Medium Ball Point
- WING = Wing
- ZWI = Double
- ZWIHO = Double Wing

Needle Size Conversion

Regardless of the system, the greater the number, the larger the diameter of the needle.

European vs. Domestic

60=8	90=14
70=10	100=16
75=11	110=18
80=12	120=19

Needle Size for Fabrics

- 60 – very fine batiste
- 70 – shirt-weight
- 80 – medium-weight
- 90 – denim and twill
- 100/110/120 – canvas

General Information

Along with thread, needles are very important to stitch formation. Many "mechanical" problems and damage to fabrics can be traced to a bent, damaged, or incorrect needle.

When selecting the correct needle, consider the following:

- Needle system – 130/705H
- Needle point – assures proper stitch formation; avoids fabric damage
- Needle size – smaller for lightweight fabrics; larger for heavier fabrics

If the needle is:

- Too small – the thread can't stay in the groove to form a loop to be picked up by the hook point
- Bent – the thread loop forms too far away from hook point and the hook can't enter the loop to form a stitch
- Blunt – the needle won't pierce fabric, so no thread loop forms to make a stitch

Need to Know

- Needles should be changed after every 4 to 6 hours of stitching, or earlier if stitches are looking bad. The needle is the most inexpensive part in your sewing machine, but it is crucial for getting good results and keeping your machine running well. Don't let false economy keep you from doing what is best for your sewing projects and your machine.
- The selected thread should fit in the groove on the front of the needle. If it isn't protected by the groove, a needle with a larger groove should be used.
- Always make sure needles are fully inserted as high as possible, with the flat side to the back.

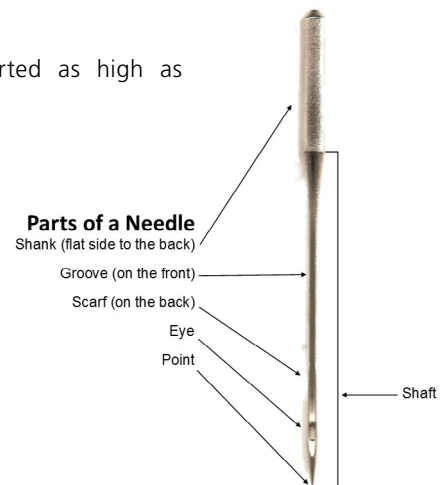

Sew HOW

Do you know how to:

- Use the bernette Creative Consultant for needle recommendations?

Reference - Sewing Machine Needles

TYPE	SIZES	DESCRIPTION
Ballpoint	60 – 100	Has a rounded point. Size 70 for lingerie, nylon, jersey; 80 for t-shirt; 90 for sweatshirt fleece.
Stretch	70 – 90	A Stretch needle has a more rounded point than a Ballpoint, and a blue anti-cling coating which helps to prevent skipped stitches in knits and elastic. Sometimes used on Ultrasuede, vinyl, and plastic.
Universal	60 – 120	A compromise between a Sharp and a Ballpoint; used on both wovens and knits.
Twin / Double	1.6/70 – 8.0/100	Two needles attached to one shank. For pintucks, hems, and decorative work. Available in Universal, Stretch, Jeans, Metallic, and Embroidery needles.
Triple	2.5/90 – 3.0/90	Three needles attached to one shank. Used to create mock smocking and other decorative effects.
Jeans	70 – 110	Has a sharp point and a shaft that is less prone to flex. The sharpness of the needle is better for use on denim and woven fabrics.
Leather	80 – 100	Point is a sharp cutting wedge. Used for leather only. Not for vinyl or simulated leathers.
Microtex / Sharp	60 – 90	Sharp point; thin shaft. Specially designed for microfiber fabrics.
Quilting	75 and 90	Thin, tapered point eliminates potential damage to fabric when seaming and cross-seaming.
Topstitch	70 – 100	A sharp point with a large eye and deep groove. For use with heavier fabrics – the large groove cradles heavier threads.
Embroidery	75 and 90	Slightly rounded ballpoint needle with large eye and groove; has a coating and a larger scarf. Prevents shredding of rayon or metallic threads. Two threads may be used through the eye.
Metafil	80	Similar to Embroidery needle with large eye and deep groove. Made of a heat-resistant alloy with a friction-reducing coating. Suitable for manufactured fibers such as polyester, acrylic, and nylon.
Wing	100 and 110	Sharp-pointed needle with a non-cutting metal wedge on each side. Makes a hole without cutting the threads of the fabric. Used for decorative and heirloom work, such as hemstitching.
Double Wing	100	One Universal needle and one Wing needle attached to a single shank.
Metallic	70 – 100	Designed for metallic threads; has a large eye and deep groove.

Reference - Threads

To achieve quality stitches, a sewing machine needs three things: suitable thread, correct size needle, and properly adjusted thread tensions. Poor quality or the wrong type of thread can cause inferior stitches on any machine. Inferior thread results in crooked and looped stitches, puckered seams, frayed thread, and/or needle breakage. Did you know that thread passes through the eye of the needle approximately 37 times in a “seesaw” action before it forms a single stitch?

Long staple threads are stronger and smoother than short staple threads. (Staple refers to the length of fibers twisted together to form a single ply). Most bargain-priced threads are usually short staple and will deposit more lint and fuzz into your sewing machine, potentially causing tension inconsistencies and possibly even damage to your machine over the long term. Using long staple threads also result in less snagging and fraying as you sew.

Ply refers to the number of strands twisted together to make a single thread. The number of plies is usually indicated by a number after the weight of the thread such as 50/3, which means a 3-ply, 50-wt. thread. The lower the weight, the heavier the thread; conversely, higher numbers indicate fine or lightweight thread.

Guidelines for Thread Weights

- 12 wt.— Couching, bobbinwork
- 30 wt.— Embroidery, bobbinwork
- 40 wt.— General construction, quilting, embroidery
- 50 wt.— General construction, piecing, bobbin thread, quilting
- 60 wt.— Lingerie, heirloom, appliqué, bobbin thread, quilting
- 80 wt.— Extra-fine lingerie, heirloom

Fibers

Fiber refers to the type of material used to produce the thread.

Polyester

Good for clothing construction on man-made, natural or blended fabrics. Tolerates high temperatures. Polyester embroidery thread has a high sheen; excellent for embroidery, very abrasion resistant, and will not fade.

Cotton

Available in a wide range of weights from 12-100, cotton thread gives a soft, full look to embroidery, appliqué, and buttonholes. It is also excellent for clothing construction on natural fibers, patchwork piecing, darning, and heirloom sewing.

Rayon

A glossy embroidery thread, rayon is not as strong as cotton and polyester fibers, making it useful for decorative work, but not for construction techniques.

Silk

Used on silk and wool fabrics, this strong, lustrous fiber is good for construction and decorative details such as buttonholes. Also used for quilting as it blends into the fabric.

Reference - Decorative Stitching

As you begin to experiment with decorative stitches on your bernette machine, there are several things you should keep in mind:

- Type of thread you plan to use
- Presser foot you select
- How you prepare your fabric

Type of Thread

Selecting the thread for decorative stitching often comes down to a personal preference and what looks best on your project.

Cotton embroidery thread, especially in a heavier weight such as 30, gives a beautiful look to the stitches and has a nice luster to it.

If you want a high sheen, rayon or polyester embroidery thread are good choices.

Do not be afraid to adjust the top thread tension for specialty threads.

Preparing the fabric

Preparing your fabric correctly can take the frustration out of your stitching, giving you a positive experience with beautiful results. The fabric needs to be stable enough to support the stitching without tunneling or puckering. This can be accomplished in several ways, sometimes with a combination of techniques:

- The fabric itself might be heavy enough to support the stitching.
- Interfacing (fusible or sew-in) can be applied to the wrong side of the fabric and left in the project.
- Stabilizers are used as a temporary form of support.

For the exercises in this class, you will be using light-weight tear away stabilizer that can be removed after stitching if desired.

Presser Foot

The presser foot you select is critical for good results because it can affect the way the fabric feeds under the needle, influencing the stitch formation.

Stitches that are more open and have less thread will stitch well with an all-purpose or zigzag presser foot.



If you are creating heavy, satin stitched patterns, you will need a foot that is not flat on the bottom. It should have some type of indentation that allows the foot to ride over the completed stitch without dragging or inhibiting the feed of the fabric.



Reference - Cleaning and Oiling

One of the most important parts of maintaining your machine is proper cleaning and oiling. Below are tips to follow, but more complete instructions for your specific model can be found in your machine's manual.

It is recommended that you clean and oil every other bobbin, or every 3-4 hours of actual sewing time. If you notice your machine sounding louder than usual, then it is time to clean and oil.

General Cleaning Steps

- Turn the machine off and disconnect it from the power supply system.
- Clean the display using a soft slightly damp microfiber cloth.
- Remove the needle. (It is recommended that you change your needle every 4-6 hours of sewing time.)
- Remove the stitch plate.
- Clean the hook race with a brush and remove all lint and threads, using the brush included with your machine.

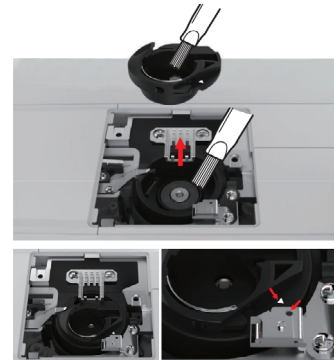

Oiling the Needle Bar

If the needle bar lacks lubrication, the needle bar might not move smoothly. If the machine is used often, the needle bar should be oiled every 6 months.

- Turn the machine off and disconnect it from the power supply.
- Remove the plug (1) and remove the screw (2).
- Remove the face cover (3). After removing the face cover, be careful of the moving parts.
- Put one drop of oil on the needle bar movement mechanism, including needle bar crank rod/needle bar bracket and needle bar supporter (add the oil on the area marked by arrow).
- Remove the presser foot.
- Turn the handwheel a few times and remove excess oil with a cloth.
- After oiling, the face cover must be remounted before plugging in the machine. Never reconnect the machine or make it run with the place cover removed.

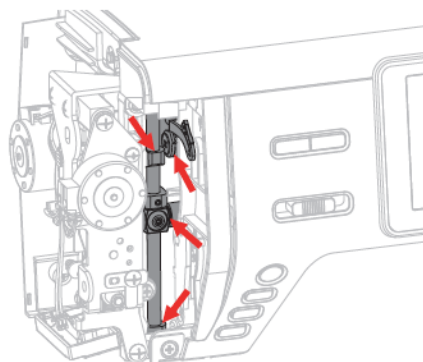
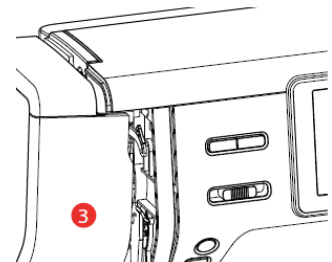
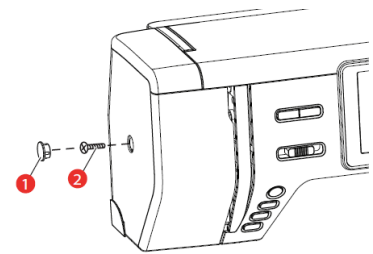

b79 and b77 Sewing Functions

External Buttons

1. Start/Stop
2. Presser Foot Up/Down
3. Auto Thread Cutter
4. Quick Reverse
5. Slide Speed Control
6. Needle Up/Down
7. Securing



SEWING FUNCTIONS

	Pattern Begin		Programmable Foot Control		Combi Mode		Pattern Repeat
	Upper Thread Tension		Needle Stop Up/Down Permanent		Edit the Complete Combination		Mirror Image Left/Right
	Needle Security		Information i-dialog		Retrieve Saved Stitch		Mirror Image Up/Down
	Presser Foot Sole Display		Stitch Selection by Number		Retrieve Combination		Balance
	Presser Foot Pressure		Practical Stitches		Save to bernette Personal Program		Pattern Extend Adjust Stitch Density
	Stitch Plate Display		Decorative Stitches		Delete from Personal Program		Stitch Density
	Home		Alphabets		Close / Cancel		Continuous Reverse
	Setup		Buttonholes				Backstepping
	Sewing Tutorial*		Quilting Stitches				Delete
	bernette Creative Consultant		bernette Personal Program				Confirm
	Eco		bernette Stitch Designer / Insert/Edit a Stitch*				Escape
	Clear - Back to Basic Setting		Triple Stitch-Stitch Designer*				
	Use Upper Multi-function Knob for Adjustment		Move-Stitch Designer*				
	Use Lower Multi-function Knob for Adjustment		Undo/Redo Stitch Designer*				
	Use Either Multi-function Knob for Adjustment		Duplicate-Stitch Designer*				
			Snap to Grid-Stitch Designer*				
			Create a New Stitch Pattern-Stitch Designer*				

Note: There is no icon for Pattern End. However, the Securing Button can be programmed to stop at the end of a pattern.

***b79 Only**