

Appliqué Zipper Pouch

Finished Size: 12" x 12" x 4"
(30.48cm x 30.48cm x 10.16cm)



Supplies Needed

- 3 – Sew Little Time® Fabric Appliqués: Love, Van and Flowers
- 1 – Tonal fat quarter (18" x 21", 45.72cm x 53.34cm) or 3/8 yd (34.29cm) for Outer Bag
- 2 – Fat quarters (18" x 21", 45.72cm x 53.34cm) or 1/2 yd (45.72cm) fabric for Lining and Bottom Accent
- 1 – Fat quarter (18" x 21", 45.72cm x 53.34cm) or 1/4 yd (22.86cm) fabric for Top Accent strips
- 1 pkg. Fabric Palette® Squares (5" x 5", 12.70cm x 12.70cm)
- Fusible fleece: 2 – 14" x 14" (35.56cm x 35.56cm) squares
- Coordinating thread
- Zipper: 12" (30.48cm)
- Fabric glue
- Rotary cutter, mat and acrylic ruler
- Basic sewing supplies
- Sewing machine and zipper foot
- Iron, pressing surface and pressing cloth

Before You Begin

Read all instructions before beginning project. Do not prewash fabrics. Before cutting, press fabrics with a dry iron on cotton setting. Use a 1/4" (6.35mm) seam allowance and sew fabrics with right sides together (RST) unless otherwise noted.

Cutting

Tonal Fat Quarter or 3/8 yd:

Cut 2 – 14 1/2" x 9" (36.83cm x 22.86cm) for Outer Bag

Fat Quarters or 1/2 yd:

Cut 2 – 14 1/2" x 14 1/2" (36.83cm x 36.83cm) for Lining

Cut 2 – 10 1/2" x 2 1/2" (26.67cm x 6.35cm) for Bottom Accent

Squares:

Cut 14 – 2 1/2" x 2 1/2" (6.35cm x 6.35cm) squares

Fat Quarter:

Cut 2 – 2" x 14 1/2" (5.08cm x 36.83cm) for Top Accent strips

Cut 4 – 1 1/2" x 4" (3.81cm x 10.16cm) for Zipper Tabs

Piecing

1. Pin and sew seven 2 1/2" (6.35cm) squares RST as desired to make a Pieced Strip 2 1/2" x 14 1/2" (6.35cm x 36.83cm). Repeat to make a second Pieced Strip. **Tip:** Place different squares at the beginning and end. They will touch when assembled (Dia. A).

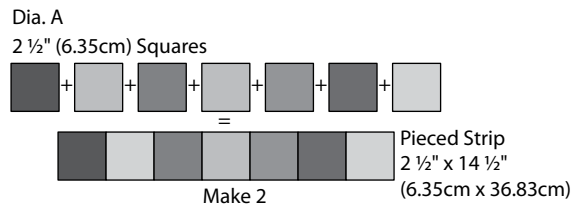

2. Fold the Bottom Accent strips (2 1/2" x 10 1/2", 6.35cm x 26.67cm) so ends meet and finger press the fold to mark the center. Repeat with both Pieced Strips. Match the center of the Bottom Accent strip with the center of the Pieced Strip and pin RST. Begin sewing 1/4" (6.35mm) from the end and stop 1/4" (6.35mm) from the other end (Dia. B). Repeat with second Pieced Strip and Bottom Accent strip.

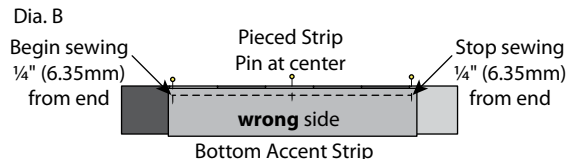

Zipper

3. Referring to Diagram C, fold and press each end of Zipper Tabs (1 1/2" x 4", 3.81cm x 10.16cm) 1/2" (1.27cm) to the **wrong** side. Unfold one end of each Zipper Tab.

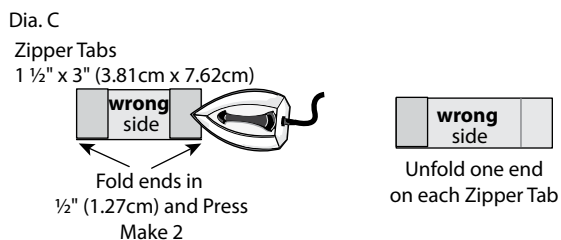

Place the Zipper **wrong** side up. At one end, place the unfolded end of a Zipper Tab with **wrong** side up and edges even, as shown. Pin and sew along crease. Repeat for additional Zipper Tab.

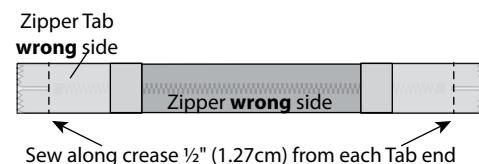
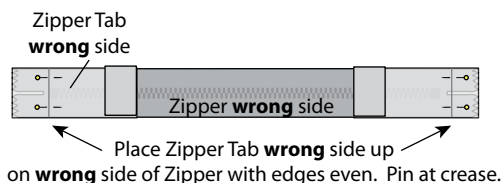

4. Turn Zipper to right side and bring folded edge of Zipper Tab over end of Zipper (Dia. D).

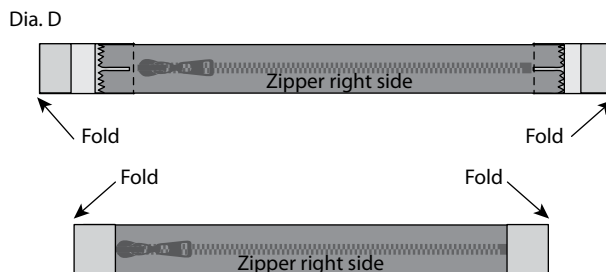

5. Refer to Diagram E to topstitch along folded edge. Repeat for opposite end. **Note: Do not stitch over metal stoppers.**

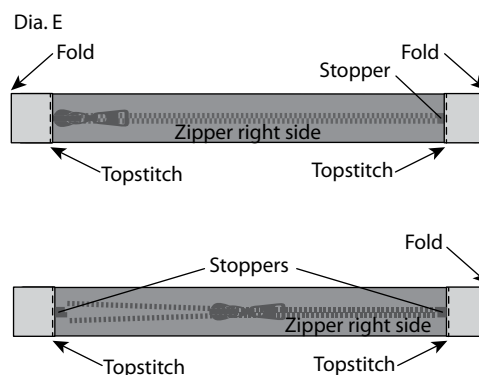

6. Install zipper foot to sew close to zipper teeth. Pin a Top Accent Strip (2" x 14 1/2", 5.08cm x 36.83cm) to each side of zipper RST. **Note: The zipper needs to be at half-zip.** Start sewing to the zipper pull. Stop sewing, remove from the needle and cut the thread. **Note: If you try to sew the length of the zipper without stopping, you may hit the zipper pull or not sew a straight line.** Close the zipper and finish sewing the Top Accent Strip to the zipper (Dia. F).

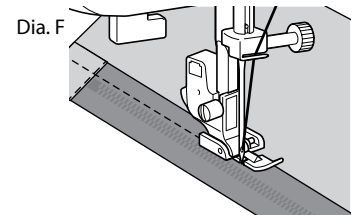

7. Trim zipper about 1/2" (1.27cm) from ends to reduce bulk in side seam. Check that zipper fits on bag and operates smoothly; trim Zipper Tab ends to match Top Accent strips then sew one side of zipper in place. Repeat with other side of zipper, sewing half way, unzipping and finish sewing. Press fabrics gently away from zipper teeth (Dia. G).

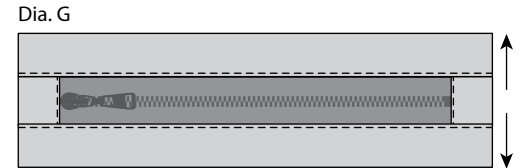

Construction

8. Refer to Diagram H to sew an Outer Bag piece to each side of the Top Accent with zipper.

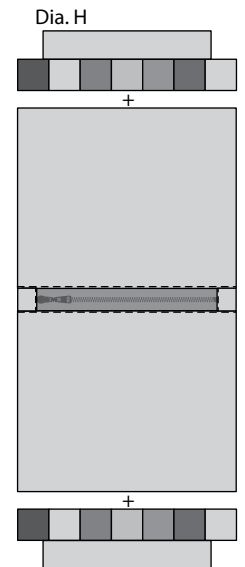

9. Refer to Diagram I to cut 2 1/2" (6.35cm) squares from two corners of each of the Fusible Fleece squares. Place on **wrong** side of bag; check fit. Optional: To reduce bulk in seams, you may want to trim fleece 3/8" (9.53mm) around edges. Cover with pressing cloth and fuse according to manufacturer directions.

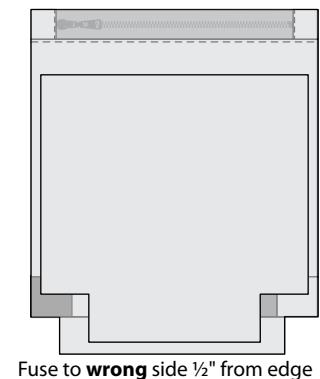
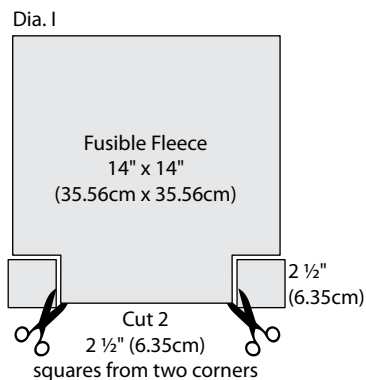

10. Appliqué placement: To sew appliqué to Bag, refer to photo or place as desired and sew close to edges (Dia. J). Accent with embroidery stitching if desired. **Note: If using fabric glue, add to finished bag.**

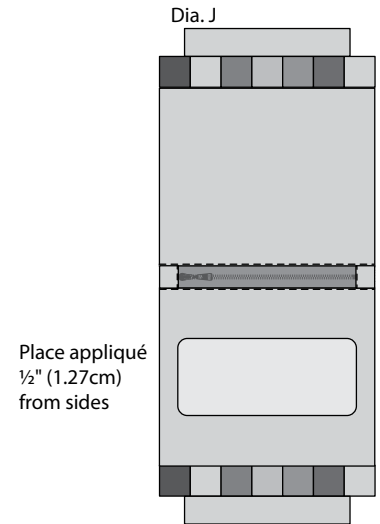

11. Refer to Diagram K to sew side and bottom seams.

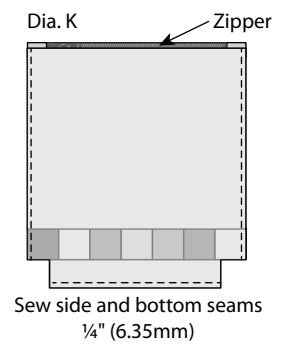

12. To box corners, match the center and side seams with cut edges even. Open and flatten the $\frac{1}{4}$ " (6.35mm) seam allowances for a neat corner point. Pin in place; sew (Dia. L).

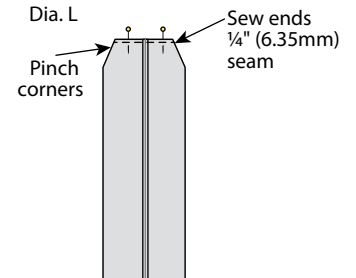

13. Fold one edge of each Lining piece ($14 \frac{1}{2}$ " x $14 \frac{1}{2}$ ") $\frac{1}{2}$ " (1.27cm) to the **wrong** side and press well. **Note: This will be the top edge.** Place the pieces RST and pin around the sides and bottom edges; sew. Refer to Step 9 to cut out $2 \frac{1}{2}$ " (6.35cm) squares from the bottom corners as shown in Diagram M.

Then, box corners as shown in Diagram L.

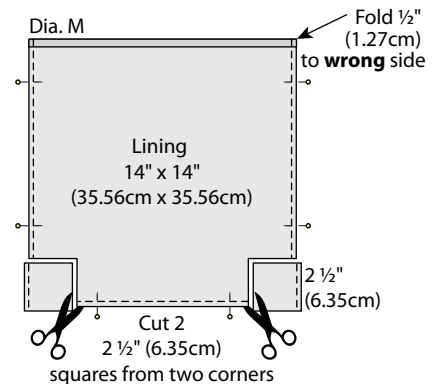

Finishing

14. Place Outer Bag inside Lining with **wrong** sides together. Pin folded edge of Lining to zipper tape and hand sew in place (Dia. N). **Note: Sew only to zipper tape to keep stitches from showing on outside of Bag.**

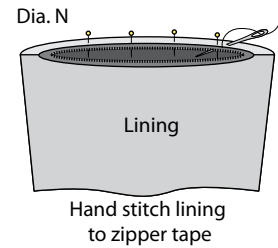

Note: If adding appliqués with fabric glue, arrange on front and/or back and glue. Allow to dry well.

Finished Care Instructions

Hand wash or wipe with a damp cloth as needed.