



# Messenger Bag

Finished size: 9" x 10"

## SUPPLIES NEEDED

- 1 - 1 Yard Canvas (Large Chevron)
- 1 - 1 Yard Cotton (Pink)
- Fusible interfacing - 18" x 42"
- 2 Coordinating buttons (1" and ¾")
- Snap (large)
- 3" x 8 ½" cardboard
- Craft glue
- Coordinating thread
- Basic sewing supplies
- Sewing machine
- Iron

## BEFORE YOU BEGIN

Read all instructions before beginning project. Do not prewash fabrics. Before cutting, press fabrics with a dry iron on cotton setting. Use a ¼" seam allowance and sew fabrics with right sides together (RST) unless otherwise noted. Remove any selvages before cutting. Finish seams using serge or zigzag stitching.



## CUTTING

Large Chevron: Cut 1 - 13" x 24" (bag)  
 Cut 1 - 13" x 13" (pocket)  
 Cut 2 - 3" x 36" (strap)

Pink: Cut 1 - 13" x 24" (bag lining)  
 Cut 1 - 13" x 13" (pocket lining)  
 Cut 1 - 3 ½" x 19" (flap closure)  
 Cut 1 - 4" x 9 ½" (bottom insert)

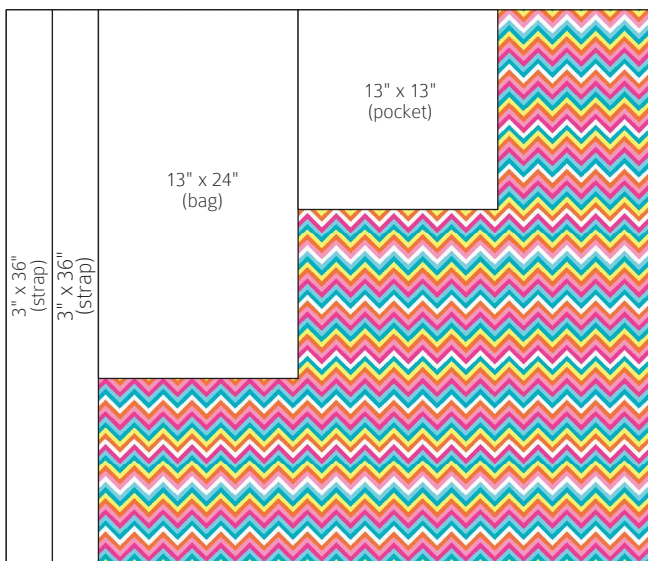

Large Chevron - 36" x 42"

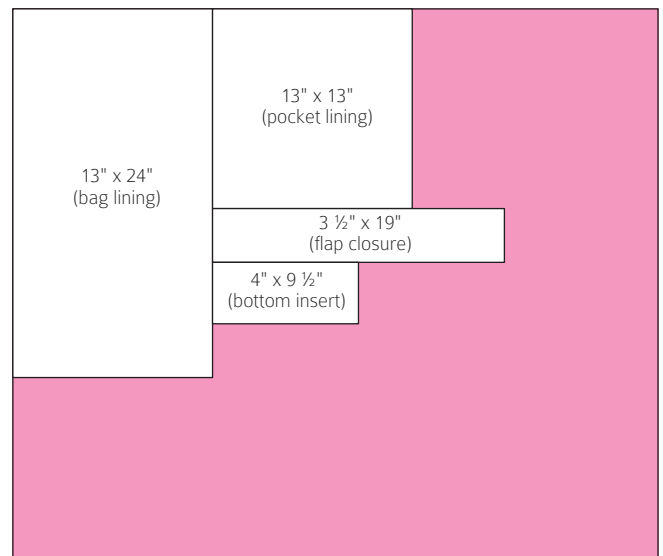

Pink - 36" x 42"

- Interfacing: Cut 1 - 13" x 24" (bag)  
 Cut 1 - 13" x 13" (pocket)  
 Cut 1 - 3" x 36" (strap)  
 Cut 1 - 3 1/2" x 9 1/2" (flap closure)

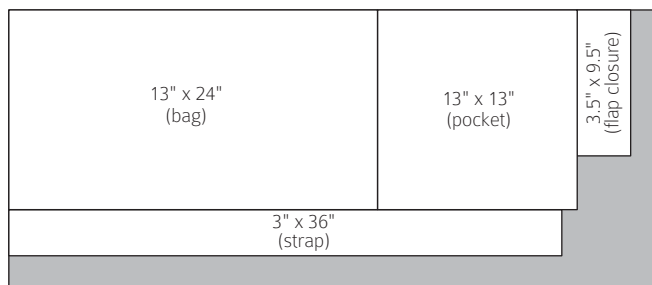

Interfacing - 18" x 42"

Following manufacturer's instructions, apply fusible interfacing to:

- 13" x 24" (bag)
- 13" x 13" (pocket)
- 3" x 36" (one strap)
- 3 1/2" x 19" (flap closure from one end to middle)

## SEWING

1. Place the canvas pocket so the chevron print is horizontal then pin to the cotton pocket lining (13" x 13") RST; sew along the top and bottom edges. Turn right side out, press and topstitch close to sewn edges.

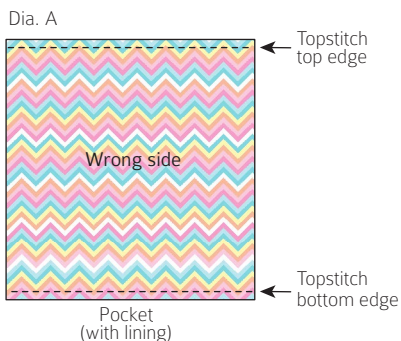

2. Center pocket right side up on the right side of the canvas bag (13" x 24") with cut edges even as shown; baste. **Note:** Check direction of chevron print. Topstitch across the center width, then measure 1 1/2" on each side of stitching and topstitch again (Dia. B).

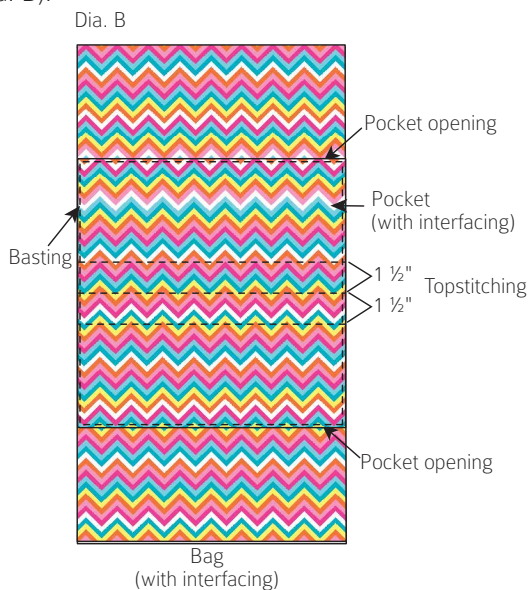

Sew two rows 1/4" apart down the pocket center to divide into four pockets (Dia. C).

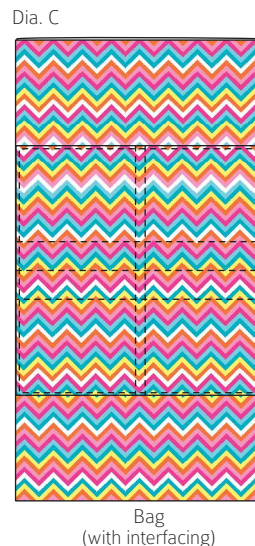

3. Fold bag RST so short edges meet. Stitch along each side using a 1/2" seam allowance. Press seams open.

4. To give the bottom a boxed shape, match the side seam on one side to the center topstitching along the bottom; pin. Measure 1 1/2" from the point and sew from edge to edge. Trim corner 1/2" from stitching; zigzag cut edges (Dia. D). Repeat for the other side. Turn the bag right side out.

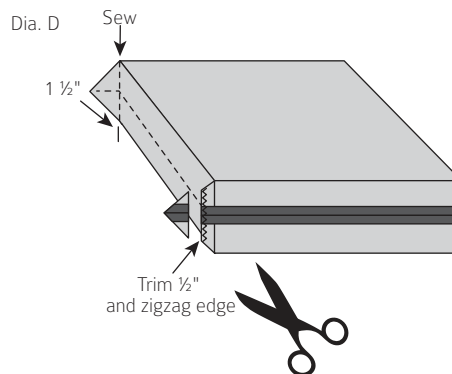

5. Place the two canvas strap rectangles (3" x 36") RST and sew the long edges. Turn right side out; press and topstitch close to edges.



6. Place ends of straps centered over side seams of bag on the right side with edges even; pin and sew (Dia. E).

7. Fold the cotton flap closure (3 ½" x 19") in half RST so short edges meet. Sew both long edges. Turn right side out, press and topstitch close to edge.

8. Pin flap closure centered at the top edge of the bag RST with cut edges even; pin and sew (Dia. F).

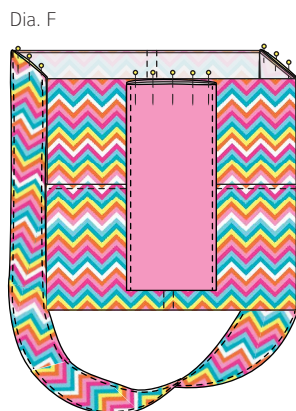

9. Fold lining RST so short edges meet; press fold lightly to crease. Sew along each side using ½" seam allowance, leaving a 5" opening at the center on one side for turning.

10. To give the bottom a boxed shape, match the side seam on one side to the center crease along the bottom; pin. Measure 1 ½" from the point and sew from edge to edge. Trim corner ½" from stitching; zigzag cut edges (Dia. D). Repeat for the other side.

11. Place bag into lining RST with top edges even. Pin and sew around the top edge using ½" seam. Turn right side out through opening. Sew opening closed and press top edge flat; topstitch close to top edge.

12. Sew the snap top to the back side of the flap centered ½" from the folded edge. Sew the snap bottom centered 2" from the bottom of bag. **Note: Keep lining free from stitching.**

13. Stack the buttons, place above the area where the snap is sewn and sew to the front of the flap.

## FINISHING

14. Center the cardboard (3" x 8 ½") on the **wrong** side of the Pink cotton bottom insert. Wrap the sides over the edge of the cardboard and glue in place. Allow glue to dry and place in bottom of bag.

## FINISHED CARE INSTRUCTIONS

Spot clean with cool water and mild detergent.