

Carry-All Caddy

Project Instructions

Finished Size: 12" x 6" x 5"

Sew Fun!



Cassovia Collection

Supplies Needed

- 1 - 18" x 42" Pre-cut (Multi Paisley - Fabric A)
- 1 - 18" x 42" Pre-cut (Red Tonal - Fabric B)
- 1 - 18" x 21" Pre-cut (Blue Paisley - Fabric C)
- 1 - 18" x 21" Pre-cut (Gold Flowers - Fabric D)
- 1 - 18" x 21" Pre-cut (Red Swirl - Fabric E)
- ½ yd. Pellon® Fusible Fleece (987F)
- ⅔ yd. Pellon® Shapeflex woven interfacing (SF101)
- 4 ¾" x 10 ¾" firm cardboard or foam-core board (bag insert)
- Coordinating thread
- Chalk or other removable marker that shows on fabrics
- Rotary cutter, mat, and acrylic ruler
- Basic sewing supplies
- Sewing machine
- Iron and pressing surface
- Quilting guide/bar attachment (optional)

Before you begin

Read all instructions before beginning project. Do not pre-wash fabrics. Before cutting, press with a dry iron on cotton setting. Use a ¼" seam allowance and sew fabrics with right sides together (RST) unless otherwise noted. Back tack to secure the beginning and end of each seam. Follow manufacturer's directions when using fusible products.

Cutting

Note: Label pieces.

- Fabric A:** 1 - 18" x 18" (bag)
2 - 4 ½" x 18" (outside pockets)
2 - 2 ½" x 18" (straps)
- Fabric B:** 1 - 18" x 18" (bag lining)
2 - 5 ½" x 18" (outside pocket linings)
2 - 3 ½" x 18" (strap linings)
- Fabric C:** 2 - 4 ½" x 18" (inside pockets)
- Fabric D:** 2 - 5 ½" x 18" (inside pocket linings)
- Fabric E:** 1 - 12" x 17" (bag insert cover)
- Fusible Fleece:** 2 - 18" x 18" (bag and lining)
2 - 3 ¼" x 18" (straps)
- Fusible Interfacing:** 4 - 5 ½" x 18" (pockets)

Fabric A

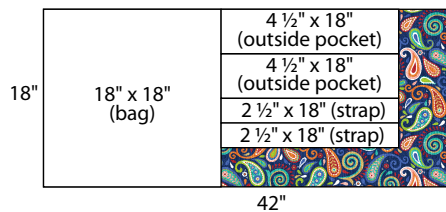

Fabric C

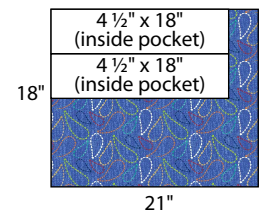

Fabric B

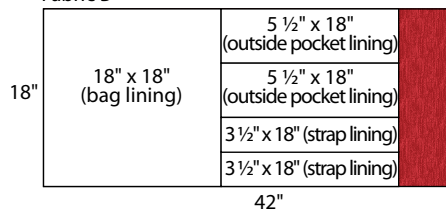

Fabric D

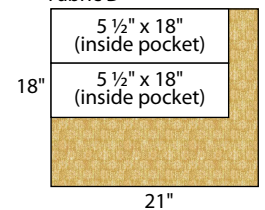

Fabric E

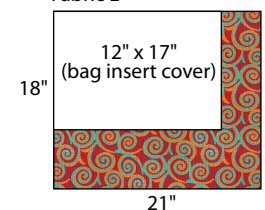

Making the Organizer and Lining

1. Place 18" x 18" fusible fleece with fusible side against the **wrong** side of bag. Fuse fleece to bag. Repeat with the bag lining.
2. On the right side of both fused squares, mark diagonal lines from corner to corner with a removable marker to make an X. If you do not have a quilting guide/bar, mark a 2 ½" grid over entire organizer and lining; otherwise, set your guide to stitch at 2 ½" intervals. Quilt with either a straight or elongated serpentine stitch. **Tip:** Test your stitch settings on a fabric scrap and adjust as needed before quilting your project. If applicable, remove quilting attachment when finished.
3. On the right side of both the bag and bag lining, draw a center line 9" from one edge. Draw lines 1 ½" from edges parallel to the bottom line for pocket placement (Dia. A).

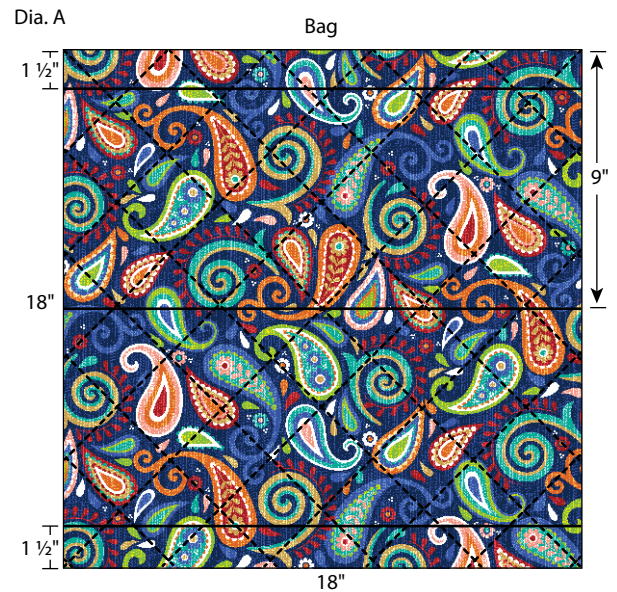

4. Fuse the interfacing to the **wrong** side of each inside pocket lining and outside pocket lining.
5. With RST, pin long edge of each outside pocket to outside pocket lining; sew. Pin remaining long edges RST, leaving short ends open; sew. Turn right side out. Press pocket flat so that one seam runs along the bottom edge and a mock binding forms at the top edge of the pocket (Dia. B). Press pocket well. Repeat for remaining pockets and pocket linings.

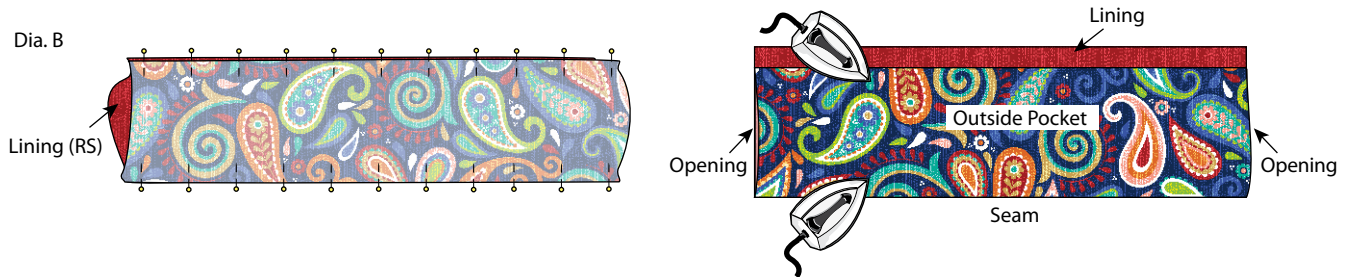

6. On the right side of the bag, place the top edges of the outside pockets on the drawn lines as shown in Diagram C. Pin in place. Sew along the bottom edge of each pocket to attach.

Baste the pocket sides to the bag. Repeat with remaining outside pocket. Add inside pockets to the lining in the same manner.

7. Mark pocket divisions on one outside pocket. Mark the center line from top to bottom, and then mark lines 3" from the center.

For the second pocket mark 6" from each short end. Sew through all layers at each marked line. Repeat for the lining pockets.

On wrong side of both bag and lining, draw a line 9" from the top edge parallel to previous stitching for boxing the corners in Step 9.

8. Fold bag RST, matching top edges and corners. **Note:** Check that the top edges of the pockets line up. Sew side seams. Repeat for the lining, leaving a 3 ¼" opening for turning in the middle of one pocket.

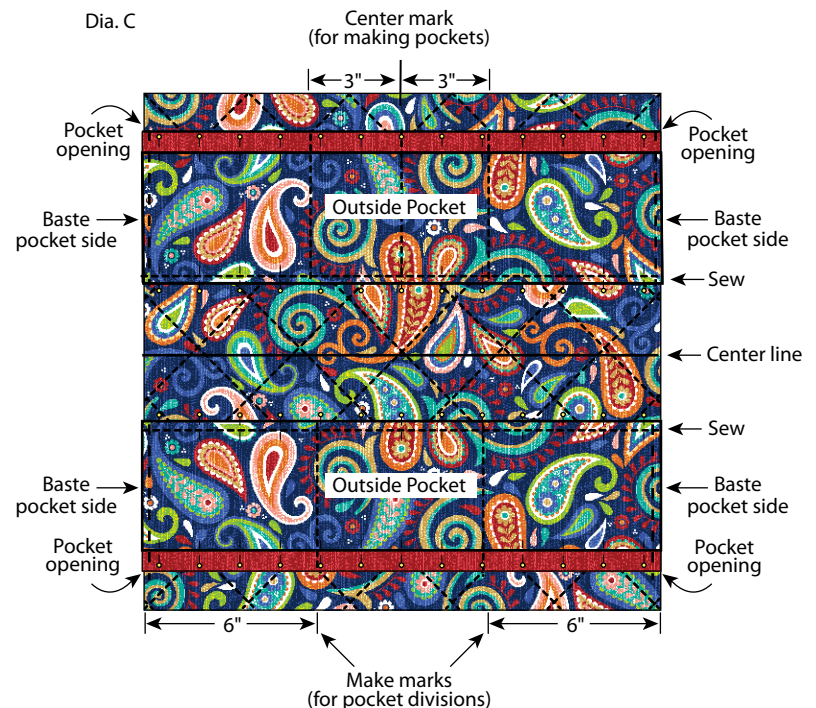

9. Box the corners by flattening the corner into a triangle, matching the drawn center line with the side seam. Draw a line 2 ½" from the corner (Dia. D). Repeat for remaining bag and lining corners. Sew along marked lines then trim ¼" from seam to reduce bulk. Zigzag cut edges.

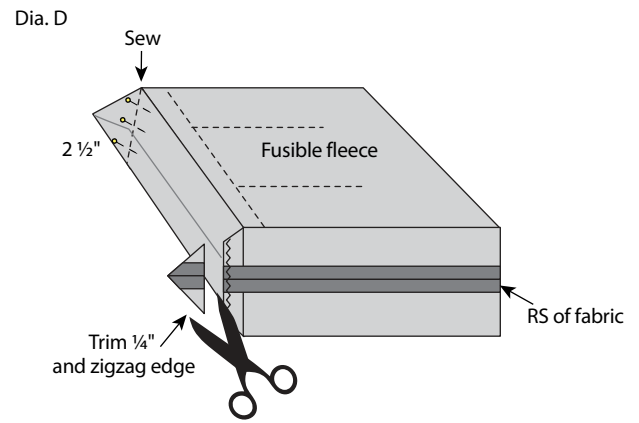

10. To shape the corners, draw a line 2 ½" from the side seam to the boxed corner seam for all bag and lining corners.

Beginning with the corner boxing seam, match the bag fronts **wrong** sides together along the 2 ½" line and pin the layers together. Repeat with all bag corners.

Starting at the bottom, edge stitch ¼" from each corner; repeat for all bag corners.

For the lining, pin corners RST and edge stitch (Dia. E).

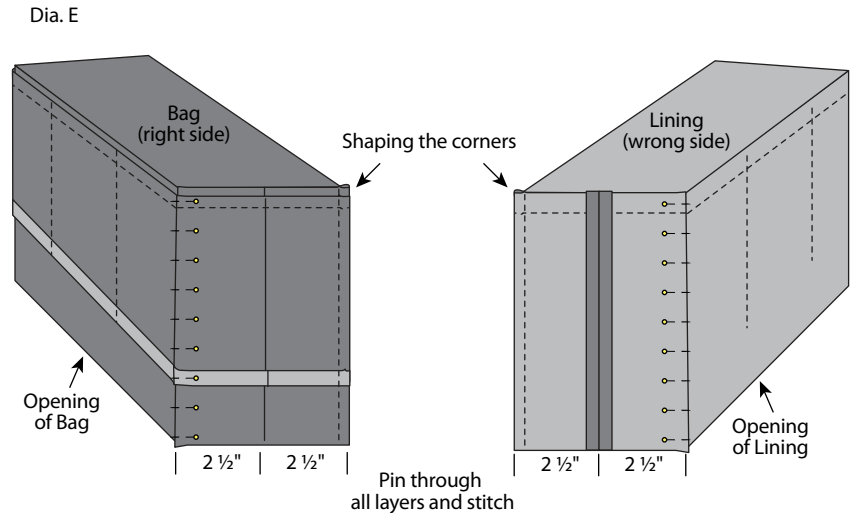

Making the Straps (refer to Diagram F)

11. Center and fuse fleece pieces to **wrong** side of strap linings.

12. Place long edges of one strap and lining RST; sew. Pin remaining long edges together and sew. Repeat for remaining strap.

Turn right side out and press so that the lining is even along both long edges. "Stitch in the ditch" between the strap and lining to make a mock binding.

13. With the lining side up, fold strap in half so short edges meet to find the center; mark. Measure and mark 2" from the center of strap.

With the strap facing up, fold the lower edge of the strap 1/3 of the distance (about ¾") toward the upper edge; then fold the upper edge over to meet the lower edge.

Pin in place and sew along the edges along the previous stitching and ¼" from the other edge between the marks to hold in place. Repeat for the second strap.

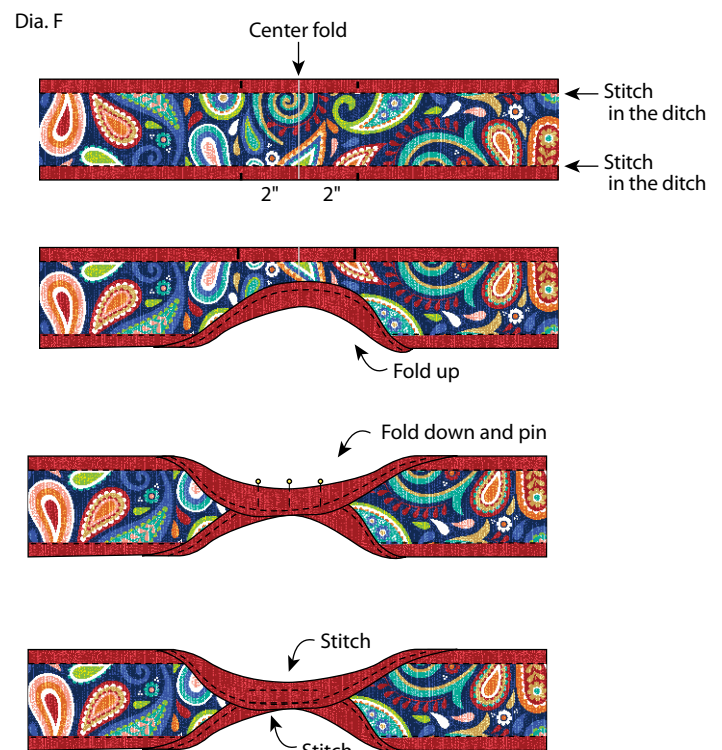

14. Find the center of each bag top edge. Measure and mark 2" on each side of the center. With RST, place inner edges of strap at marks, lining up ends with bag top; pin (Dia. G). **Note:** The red lining should be showing on the strap. Sew and reinforce stitching. Repeat with second strap.

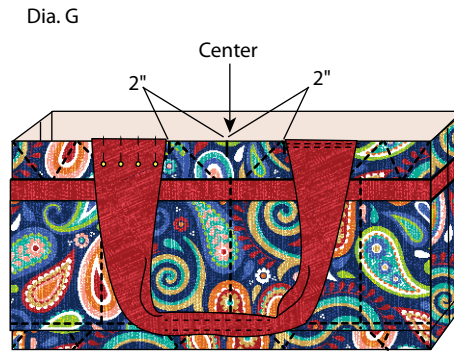

Finishing

15. Place bag inside of lining RST. Pin top edges together, placing the topstitched corner seams in opposite directions to offset bulk; sew. Turn right side out through opening in lining. Hand stitch opening closed.

16. Press top edge and topstitch close to edge. Remove construction lines from project.

17. *Insert cover:* Fold and press bag insert cover $\frac{1}{2}$ " twice to the **wrong** side on each 12" end; stitch to hem. Fold in half RST, matching hemmed ends and aligning cut side edges; sew side seams. Turn right side out and slide insert inside. Fold ends under and place in bottom of bag.

Finished Care Instructions

Remove insert (if used); hand or machine wash in cold water, gentle cycle. Hang to dry or tumble dry low.