

Corner Beam™ Tool Basics

This wonderful little unit can add real spark to your quilting bag of tricks. With the Corner Beam™ tool you'll be able to quickly cut the required shapes from strips and squares and know that they are slightly oversized for easy sewing. No need to fuss about matching sewing points, just line up the raw edges and stitch. The resulting units will be slightly oversized which then allows you to trim each to a very precise size with seams in exactly the right

alignment. Each one is perfect.

Each block consists of three elements - the "center beam" and two "side triangles." The side triangles need to be mirror images of each other. To achieve this simply cut your shapes with your fabric strips folded either right sides or wrong sides together. This is the way that most of us cut our fabrics naturally. The "center beam" will be cut from squares in order to maintain the grain line integrity of each unit. It will result in some waste, but it is waste

that would occur even if you were cutting each shape individually using templates. The nice thing is, these waste triangles can actually be used to create additional smaller units, either Corner Beam™, V-Block®, or Split Rects™ units. With the center beam it is not critical that the starting fabric squares be right sides or wrong sides together. It's a non issue.

The chart gives you several bits of information. It lists the desired Finished Size and Cut Size of your unit, start-

ing size for strips and squares, the number of squares/ beams and side triangle pairs that can be cut from each strip and the last column will give you a suggested size unit to make using the waste triangles. Of course you may just decide to move those waste triangles into the trash can, but that decision will be up to you. FYI the starting size of the strips and squares for each unit is also listed right on your ruler so once you understand the workings of the tool, you won't even need to refer to the chart.

Finished (Sewn) Size of Unit	Cut Size of Unit (Trim Size)	Side Triangle Strip	# Side Triangle Pairs per Strip Width	Center Beam Squares	# Center Beams per Strip Width	Largest Size Unit Made from Waste Triangles
1"	1½"	2"	22 Pairs	2"	20-21	none
1½"	2"	2½"	19-20 Pairs	2½"	16-17	none
2"	2½"	3"	17-18 Pairs	3"	14	1"
2½"	3"	3½"	16 Pairs	3½"	12	1½"
3"	3½"	4"	14 Pairs	4"	10	2"
3½"	4"	4½"	13 Pairs	4½"	9	2½"
4"	4½"	5"	12 Pairs	5"	8	3"
4½"	5"	5½"	11 Pairs	5½"	7	3½"
5"	5½"	6"	10 Pairs +	6"	7	4"
5½"	6"	6½"	10 Pairs	6½"	6	4½"
6"	6½"	7"	8 Pairs +	7"	6	5"



Cutting the Center Beam

Step 1 - Stack your cut fabric squares about 4 to 6 layers deep. Find the dashed line on your ruler labeled **Center Beam Trim #1**.

Step 2 - Position the dashed line against the raw edge of your stack of squares. The illustrations show positioning for both right handed and left handed trimming.

Step 3 - Trim along slanted edge of ruler. The triangle fabric pieces under the ruler are waste triangles, but you do have the option of trimming them down to create pairs of side triangles for smaller size units.

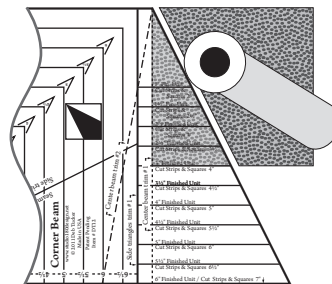

Step 2 & 3 - Position & Trim for Right Hand

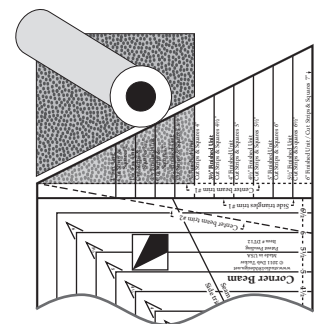

Step 2 & 3 - Position & Trim for Left Hand

Step 4 - Lift and reposition the ruler and locate the line labeled **Center Beam Trim #2**. Carefully reposition the ruler and this dashed/dotted line on top of the raw edge you just trimmed.

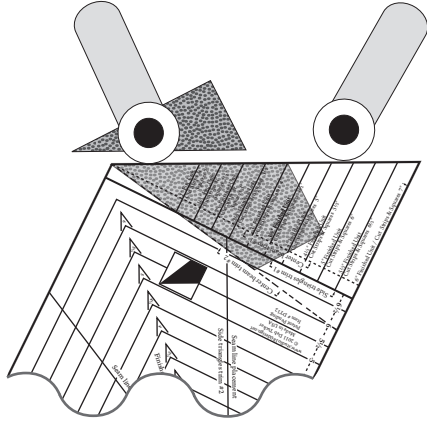

Step 4 & 5 - Reposition & Trim for Both Right & Left Hand

Step 5 - Trim again along the slanted edge of the ruler. The resulting shapes will have the exact angle needed to produce your **Corner Beam™** unit and it will also be just slightly oversized. There will also be waste triangles from this cut that will be mirror image to those made with the first trim.

Cutting the Side Triangles

Step 6- Fold and Trim. Make sure your strip is folded either right sides together or wrong sides together in order to get mirror image pairs that you'll need for each unit. Trim away any selvages from the ends of your strips.

Step 7 - Locate and Position the line labeled **Side triangles trim #1** on your ruler. It is a slightly broader line near the slanted edge of the tool. Position this broad line on the trimmed end of your folded strip. The illustrations show positioning for both right handed and left handed trimming.

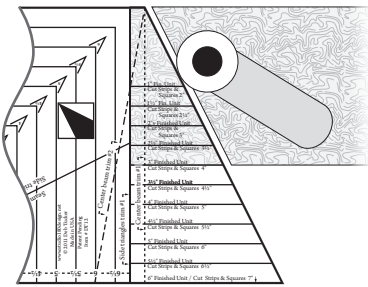

Step 7 & 8 - Position and Trim for Right Hand

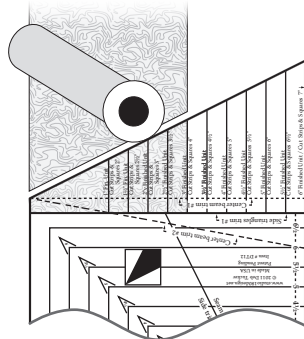

Step 7 & 8 - Position and Trim for Left Hand

Step 8 - Trim along the slanted edge of your ruler to produce your first pair of side triangle shapes. Remember these too are slightly oversized.

Step 9 - Rotate the ruler one quarter turn counterclockwise.

Step 10 - Locate and position the line labeled **Side triangles trim #2**. This is a shared line with one of the **Seam line placement** lines for the sewn unit. **Position this Side triangles trim #2** line up against the slanted edge of the strip that was just trimmed. You'll also want to locate the short, broad line near the square corner of the ruler that reads **Second trim**. Position that line at the bottom, raw edge of the strip (or at the right hand raw edge of the strip if you are cutting left handed). This step may seem a bit confusing at first, but after cutting one strip you'll be zipping right along.

Step 11 - Trim. Make your second trim along the longest edge of the ruler. This will give you your second pair of side triangles.

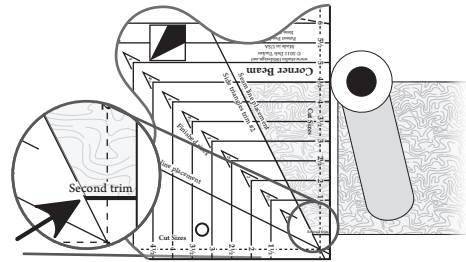

Step 10 & 11 - Position and Trim for Right Hand

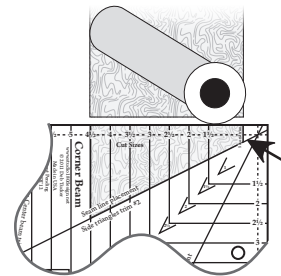

Step 10 & 11 - Position and Trim for Left Hand

Step 12 - Rotate Back and Repeat. Rotate the ruler back one quarter turn clockwise, position the Side triangles trim #1 line on the trimmed edge and repeat your cut along the slanted edge of the ruler. Continue to do this position, trim, rotate, position, trim, rotate until you have cut the desired number of side triangle pairs.

Step 13 - Organize. Once you have your center beams and your side triangle pairs cut, you'll want to lay them out right sides up at your sewing machine. Look carefully so that they are positioned as shown in the diagram. Make sure that the longest edges of the side triangles are positioned to sew to the center beam. If not you'll have some serious "unsewing" to deal with!

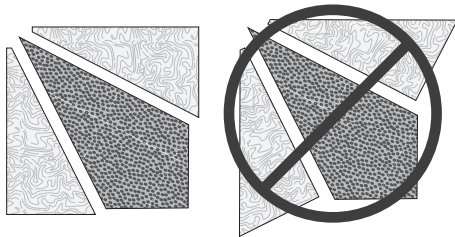

Step 13 - Organize

Step 14 - Sew and Press, then Sew and Press. Layer pieces right sides together and raw edges even. I will sometime shift the pieces slightly as shown in the diagram to make sure I have a nice amount of fabric on all sides when I go to do my trim down at the end. Practice this a bit and you'll see what I mean. Stitch one side triangle into place, press, and then stitch the other side triangle into place. It is important to make sure you press the first side out before adding the second side triangle or again you'll be giving your seam ripper a workout!

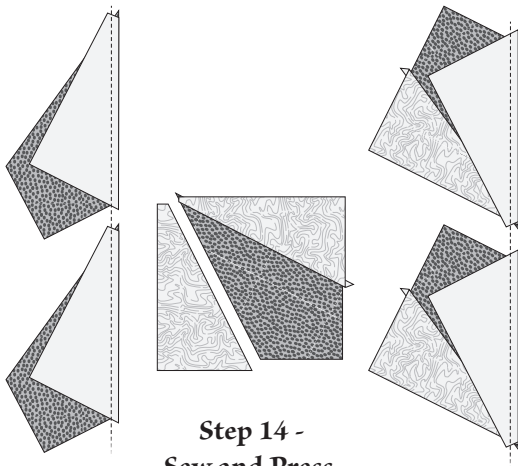

Step 14 - Sew and Press, Sew and Press

Step 15 - Trim. For your first round of trimming you should always position the pointy end of the fabric unit in the upper right hand corner if you are right handed or in the upper left hand corner if you are left handed. Carefully line up the diagonal **Seam line placement** guidelines on the tool directly on top of the sewn seam lines. Pay close attention to the point where the seams cross. Careful alignment here will give you the crisp points we're all wanting in our projects. Trim up the side and across the top to square your first corner.

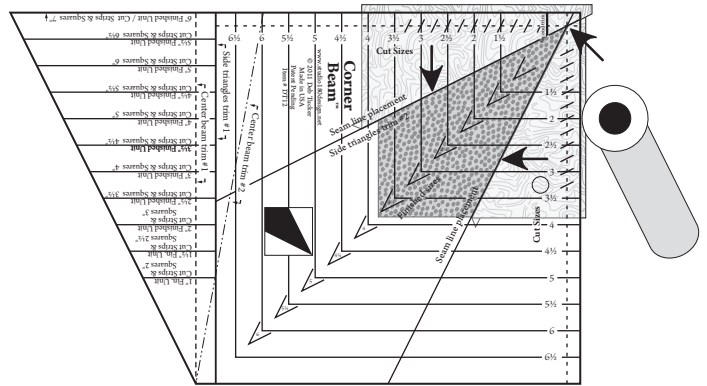

Step 15 - Trimming for Right Hand

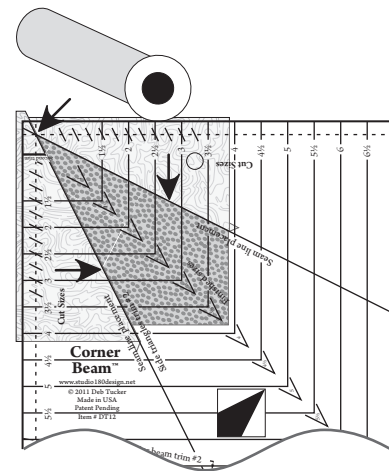

Step 15 - Trimming for Left Hand

Step 16 - Rotate and Position. Lift the ruler, but keep it in the same general position. Rotate the fabric unit one half turn. The trimmed corner with the pointy end will be in the lower left (for righties) or in the lower right (for lefties). Place the V shape guide with your desired finished size on the pointy seam crossing, place

the square up Cut Size lines on the previously trimmed edges and align the small tick lines on the far ends of the sewn seams. **Remember that your Cut Size alignment will be 1/2" larger than your desired Finished Size to accommodate your seam allowances!**

Step 17 - Trim the remaining two sides to square up the unit. It will now be exactly the right size, with seams in exactly the right position to fit perfectly into your piecework projects!

This basic unit can now be used confidently in your quilting block designs. With the size options available and the high precision end results I know that I will be adding it to more and more of my projects.

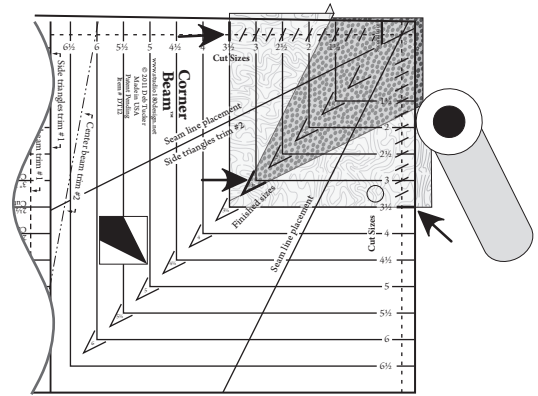
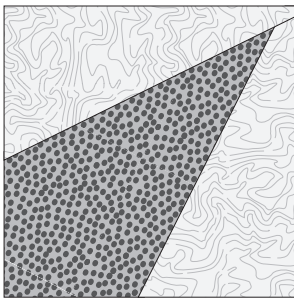

Step 16 & 17 - Position and Trimming for Right Hand

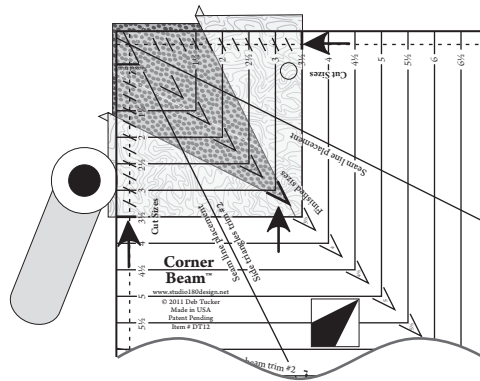

Step 16 & 17 - Position and Trimming for Left Hand

Enjoy your new Corner Beam™ tool and be sure to check out our **Fundamental Tools** for making basic units as well as our **Rapid Fire®** line of tools and techniques. Find them at your local quilt shop or by visiting our website

www.Studio180Design.net

and don't forget to watch our free online video demonstrations whenever you need an initial introduction or review.