

Check it Out! Kit Specs.

White – 1 Charm & 1 Cake

Red 'Linen' Print – 1 Jelly & 1 Cake

Pink Cherries – 1 Jelly & 1 Cake



Charm = 5" Square, Cake = 10" Square, Jelly = 2.5" x WOF

February 2017

Sample – colors in kit are better!



Woven Heart
Jhärtkorgar

Cutting Directions are written with rotary cutting in mind.
You will need a 45mm Cutter, Rulers, and Self Healing Mat.

IMAGES NOT TO SCALE – OBVIOUSLY!

Cutting Directions:

Stack the White, Pink Cherries and Red Cake. (In this order!*)

Cut Two (2) 4.5" x 8.5" Rectangle

Set Aside

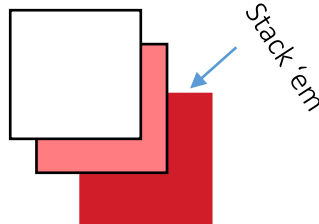
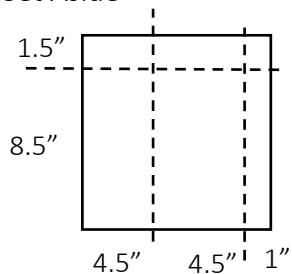

The Right Ruler For the Job!
6.5" x 24.5" Ruler or 6.5" x 12.5"
and 6.5" Square Ruler!

White Background – 1 Charm

Trim to 4.5" Square

Set Aside

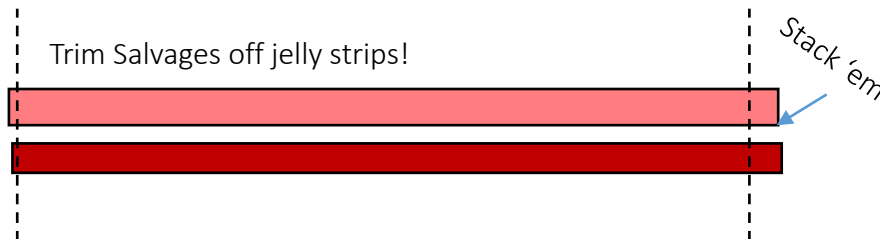
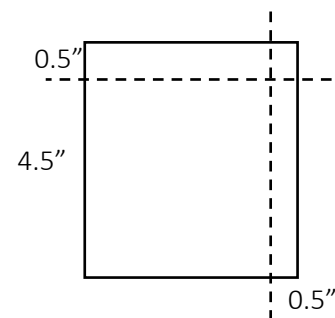

Summary of Cut Pieces:

2 White
4.5" x 8.5" rectangles

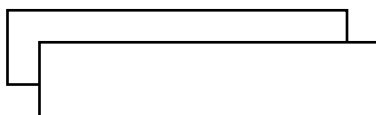

2 Pink Cherries
4.5" x 8.5" rectangles



2 Red
4.5" x 8.5" rectangles



1 White
4.5" square



Salvage trimmed Red and Pink Cherries Jelly

*Why stack 'em by color value? Answered in Lecture.

Sew – Sew -- Sewing Time!!!

Step 1. Making the Checkerboard Strip Sets:

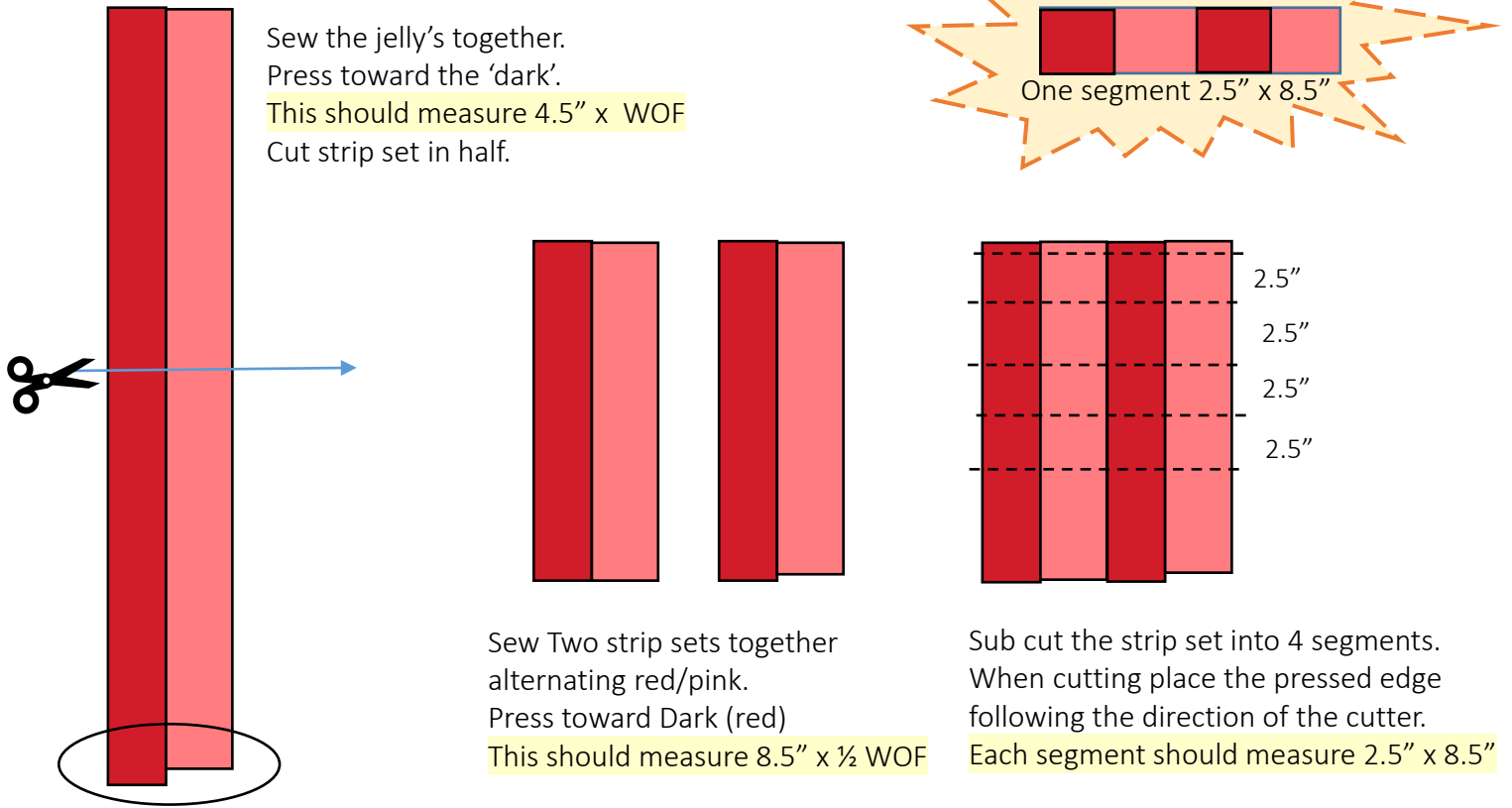

This should match up but if it doesn't – don't stress!

Step 2. Applique shapes:

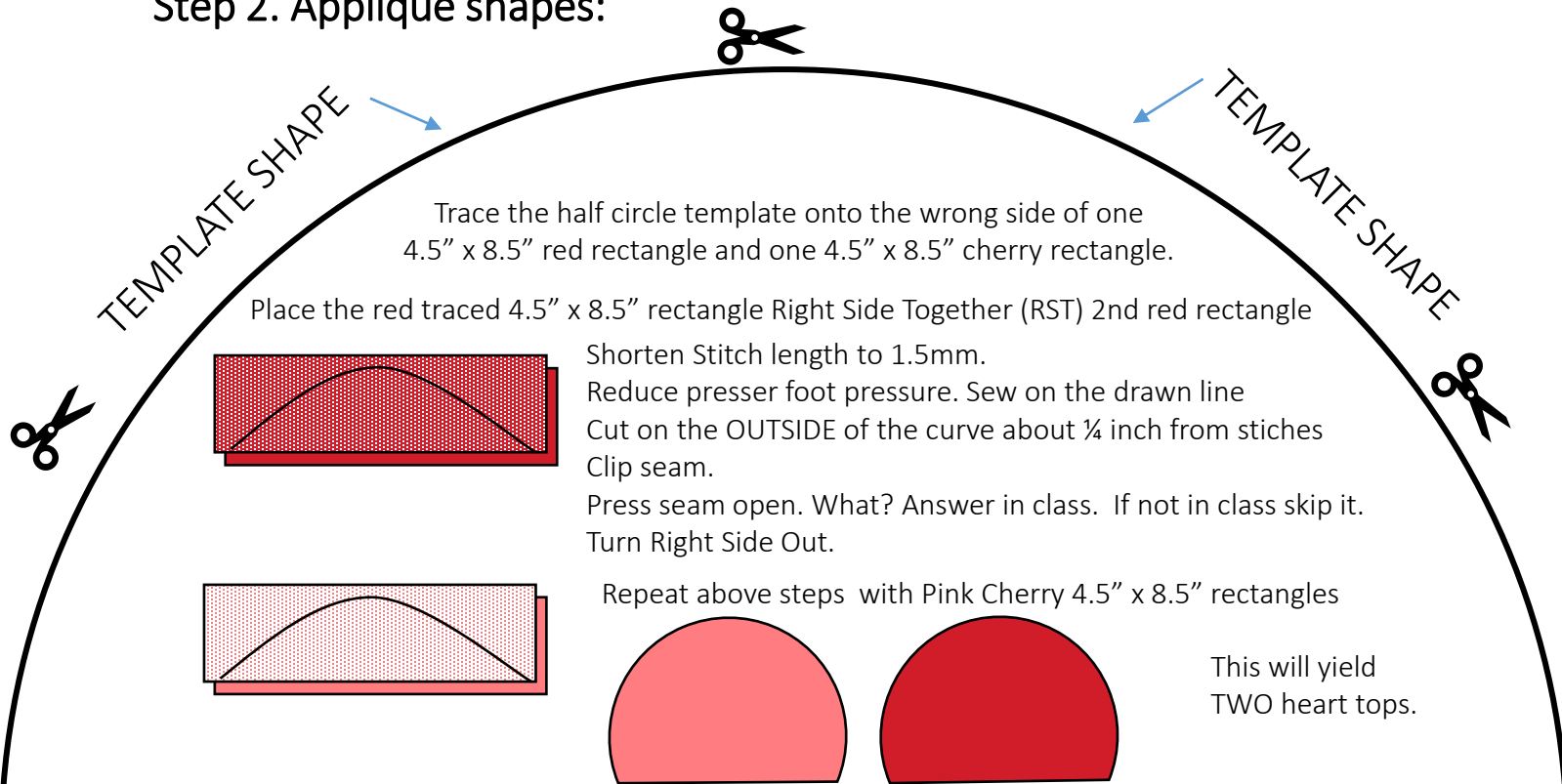

We've got our components but, do a quick inventory before we start!

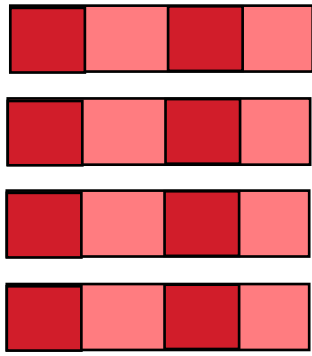

Four checkered segments 2.5" x 8.5"

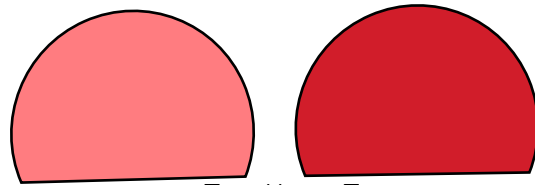

Two Heart Tops.



One White 4.5" Square.

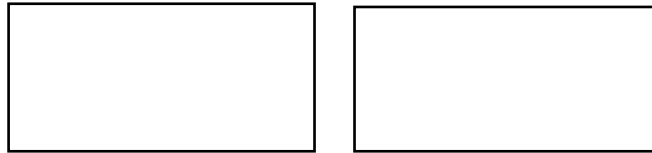

Two White 4.5" x 8.5" Rectangles.

Step 3. Assembly -- Let's Put this block together:

Construction 1:

Take the four checkered segments. Alternate the 2nd and 4th segments. Sew rows together nesting seams.

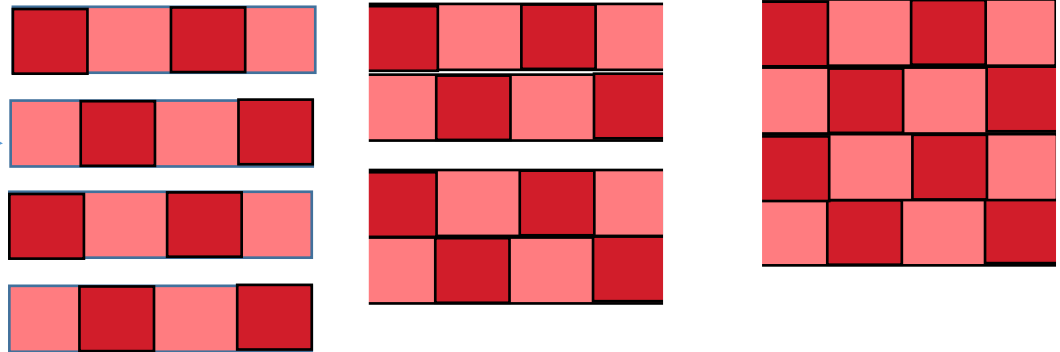

Construction 2:

Applique the Heart top onto the white 4.5" x 8.5" rectangle. Do this with both heart tops.

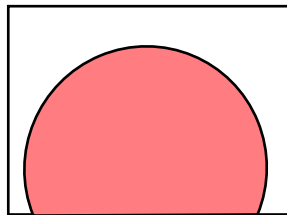

For More Info About Blanket Stitch Applique.

<https://www.bernina.com/en-US/Experience-en-US/Sewing/Sewing-ebooks/JSleBookMachineApplique>

Info applies to ALL Sewing Machines – NOT JUST BERNINA. 😊

YAY– Put it together!

Your heart block will look less Micky and more Heart-Y. Refer to photo of actual block not illustration. 😊

Construction 3:

Sew one heart top to the 4.5" square. Press toward the heart.

Sew the checkerboard to the other heart top. Press toward the heart.

Sew rows together.

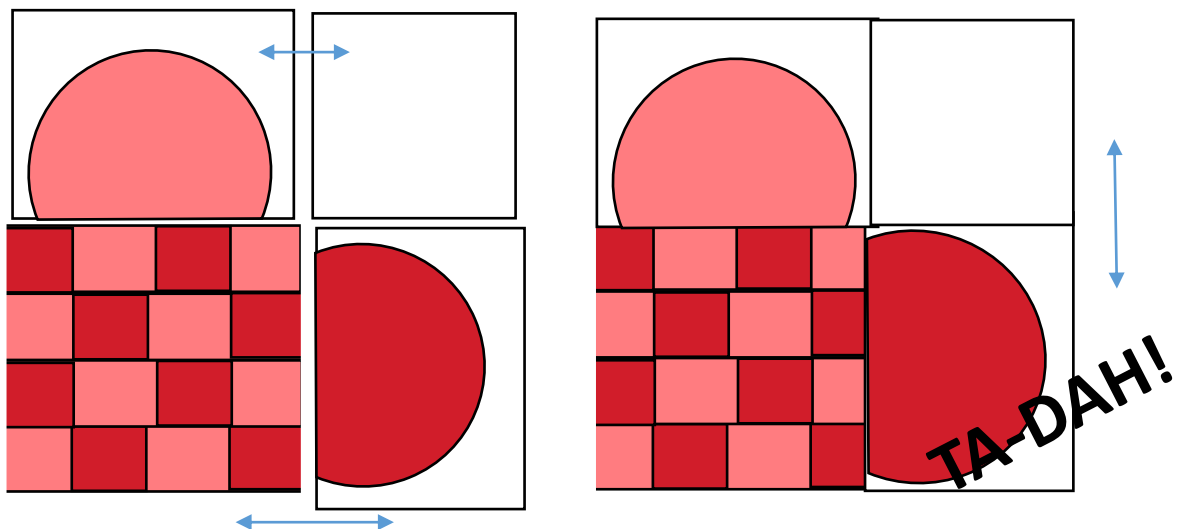

MODERN SCANDI MYSTERY QUILT

Glorianne Andersen

If ya wanna play!.... Number 2 installment Finished Quilt Should Measure 82" x 82"

Row 2 uses a similar block to February's heart block – minus the applique. This block should finish 9.5"
This Row will be continued in November 2017.

Fabric needed 2 fabric kits (TOTAL)

or

White – 2 cake and 2 charm

Red - 2 jelly and 2 cake

Pink - 2 jelly and 2 cake

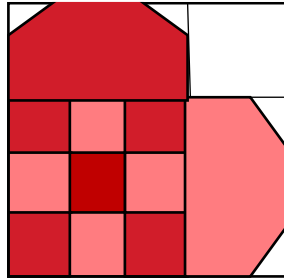

Make 4 Heart Blocks

Making the 9 Patch

Cut Pink and Red Jelly rolls in half length wise. Jelly's should measure 2.5" x 1/2 WOF

Arrange in strip sets and sew. You will have two jelly halves left over – put aside for row in March.



Assemble into 9 patches

Sub cut strip set into 2.5" strips, the length of the strip set. Should yield 8 for each set.

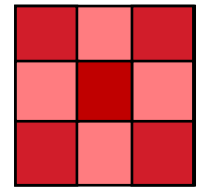
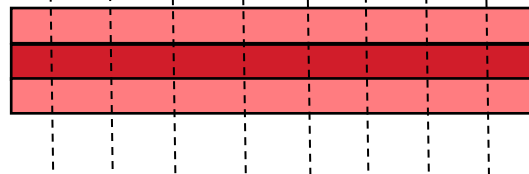
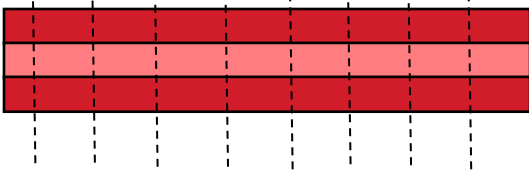

This Should Measure 6.5" square

Take 1 white Cake and Sub cut into 16 2.5" squares.

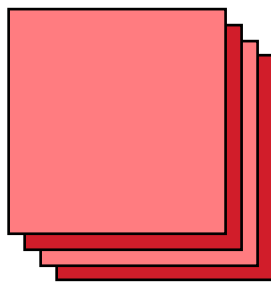
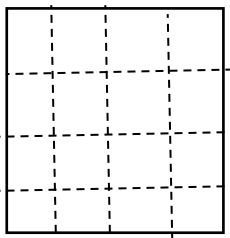

Layer the pink (2) and red (2) cakes and sub cut into 6.5" x 4"
– This will yield 4 pink and 4 red measuring 6.5" x 4"

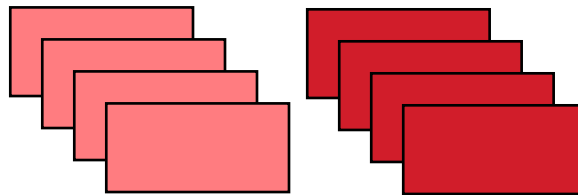

Take 1 white Cake and
Sub cut into four (4)
4" squares.

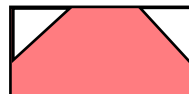
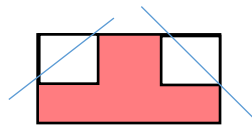
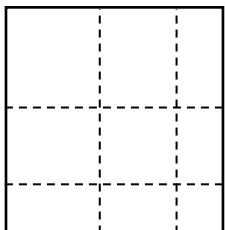

This Should Measure 6.5" x 4"

Stitch 1 2.5" white square on to the corners
RST as shown.
Flip the corners back to the stitch line and
press carefully. Trim off inside fabric. Repeat
with the rest 6.5" x 4" rectangles.

Assemble block as shown.

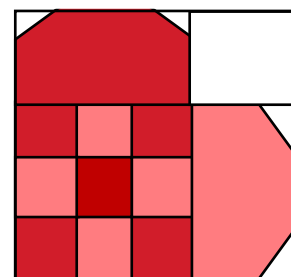

At this point -
This Should
Measure 10"
square

Questions, comments, or concerns.

Feel free to contact me at

GlorianneAndersen@gmail.com

Put the 4 completed blocks aside and imagine how good it will
look when it's complete in November!