

**Warning:** These Applique Turners were not made for oral use. DO NOT PUT IN YOUR MOUTH. Moisture will swell the wood and will reduce the life of your Applique Turners. The fibers in the wood will grab your fabric and aid in turning. You do not need to moisten the turner.

### Inner or Outer Curves

Remove several basting stitches. Place the Applique Turner perpendicular to your stitching line. Gently push fabric under. Be sure your curve flows gently from your basting stitches in front of our needle through to your basting stitches behind your needle.

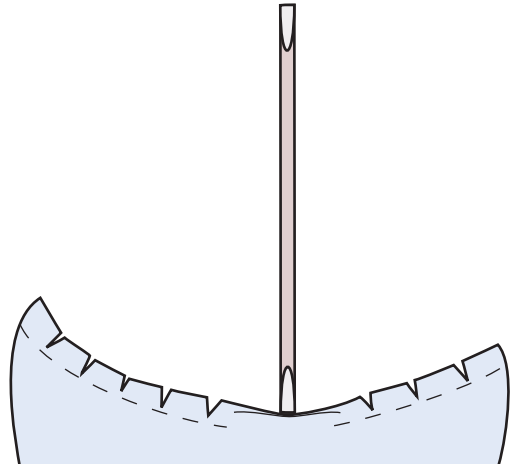
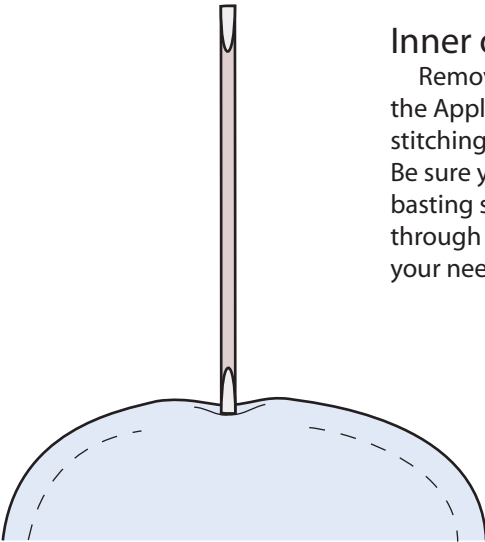

### Inner Point-Going In

Stitch to within 1/2" of inner point. Remove all basting stitches into the point. Also remove 1/2" of basting stitches going out of the point. Slip the Applique Turner under the applique and into the point. Pull back, sweeping the raw edge under. Stitch into the point.

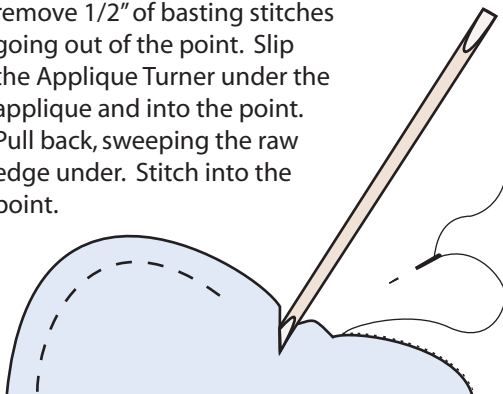

### Inner Point-Going Out

Remove 1/2" - 3/4" of basting stitches. Insert the Applique Turner 1/2" - 3/4" away from the point. Turn under the seam allowance and pull the Applique Turner down towards the point, sweeping the seam allowance under as you go.

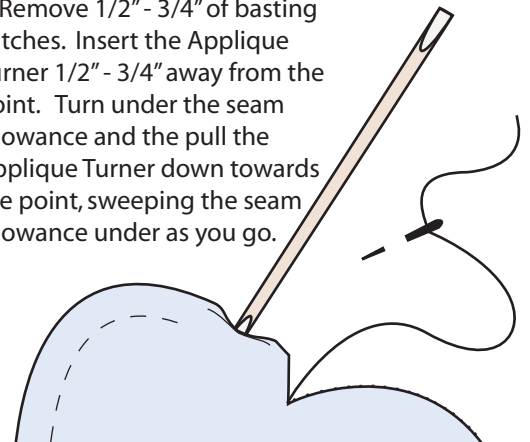

Note: Your applique turners are individually hand-crafted. It is normal to see differences in length, size and shape. It is also normal to see individual wood fibers around the turning edge. These fibers grab the fabric to help turn it.

Apple Blossom Quilts  
 PO Box 486  
 Webster City, Iowa 50595  
 abqhaidle@mchsi.com  
<http://www.appleblossomquilts.com/>  
 515-835-0457

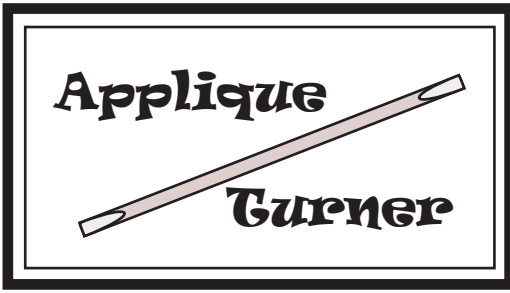

**Warning:** These Applique Turners were not made for oral use. DO NOT PUT IN YOUR MOUTH. Moisture will swell the wood and will reduce the life of your Applique Turners. The fibers in the wood will grab your fabric and aid in turning. You do not need to moisten the turner.

## Method 1

### Outer Point - Step 1

Stitch to and secure point. Using the Applique Turner, sweep the seam allowance under so that the edge of the seam allowance underneath the applique is aligned with the edge just stitched.

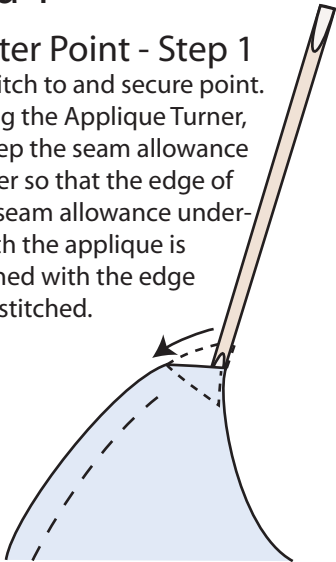

### Outer Point - Step 2

Reposition the Applique Turner as in the diagram. Gently push the seam allowance under.

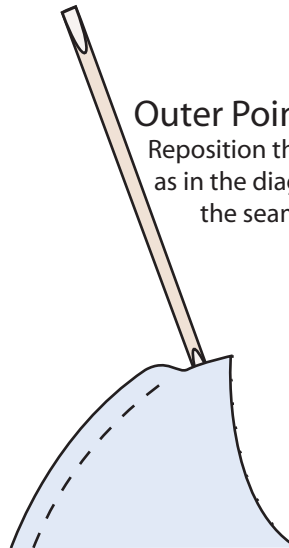

## Method 2

### Outer Point - Step 1

Stitch to and secure point. Using the Applique Turner, turn the seam allowance under at the point. Turn it under so that it forms a straight line across the point.

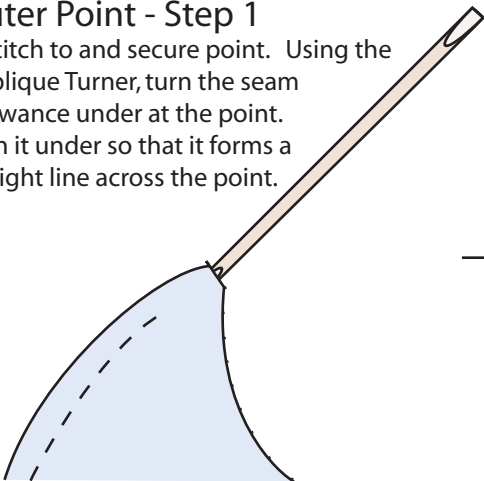

### Outer Point - Step 2

Reposition the Applique Turner as in the diagram. Gently push the seam allowance under.

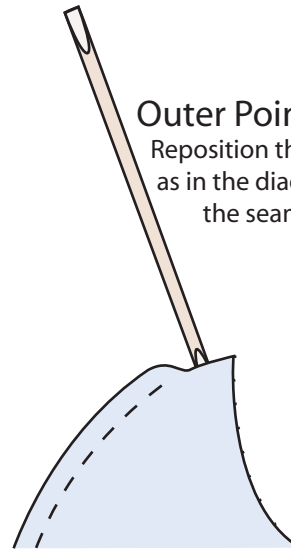

Apple Blossom Quilts  
 PO Box 486  
 Webster City, Iowa 50595  
 abqhaidle@mchsi.com  
<http://www.appleblossomquilts.com/>  
 515-835-0457