

Binding a Jewel Box Decagon

Don't let this unusual shape scare you! It's not as difficult as you might think.

For me the key was realizing you don't have to tuck in as much to make the turn as you need for corner on a square quilt.

Prepare the binding strips

- Cut 2½" strips and sew the strips together as you would for any other quilt.
- Fold the strip in half and press.
- Place the strip on the edge of front side of the quilted decagon, raw edges matching.

If your tuck is too big you get corners that look like this:

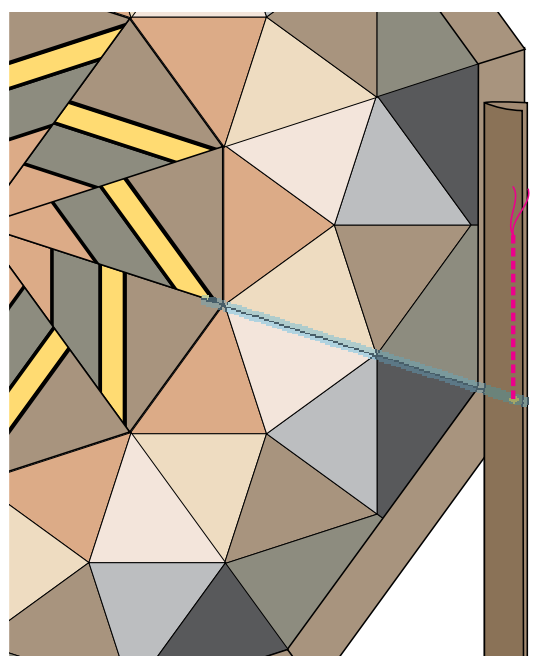
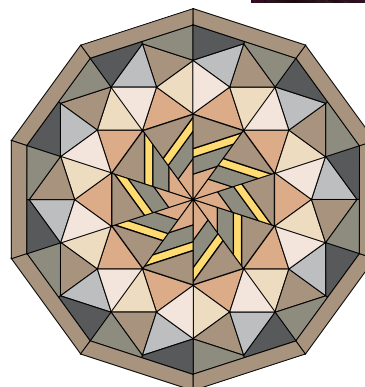

Sew the strip to the quilt

Start at the midpoint

Set the needle where the angle of the seam line intersects the binding

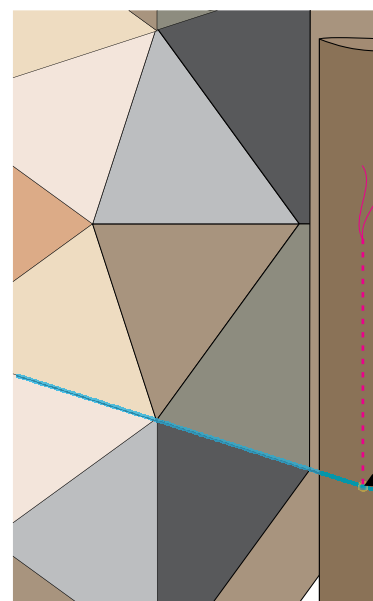

enlarged view

Rotate the quilt with the needle still in the down position

Back stitch off the edge

When you first try this, you may find it easier to cut the thread so you'll have room to manipulate the fabric.

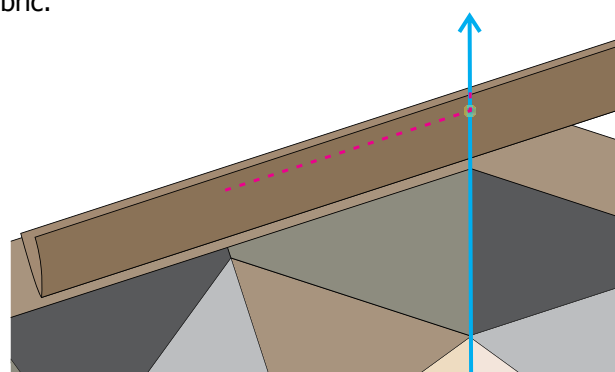
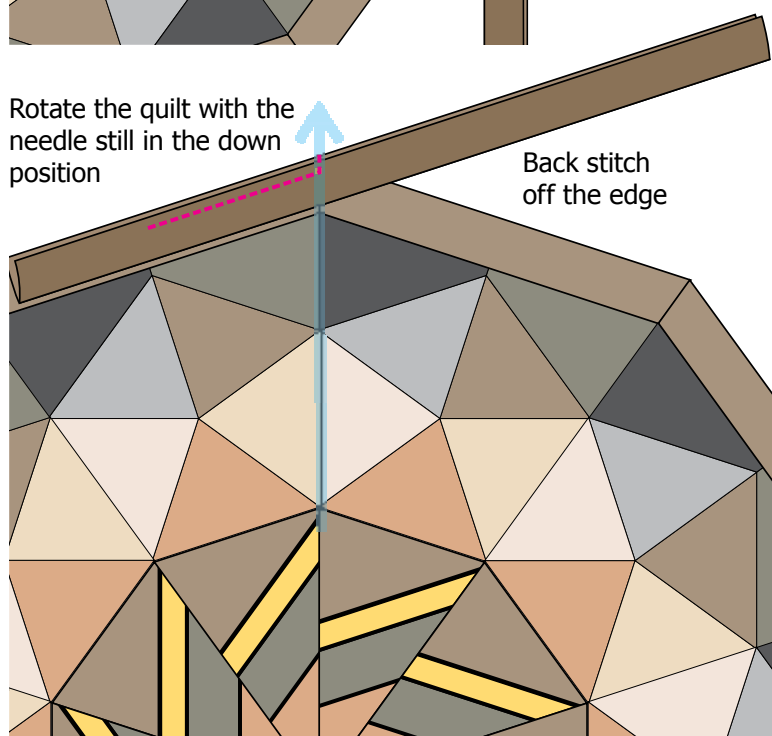

enlarged view

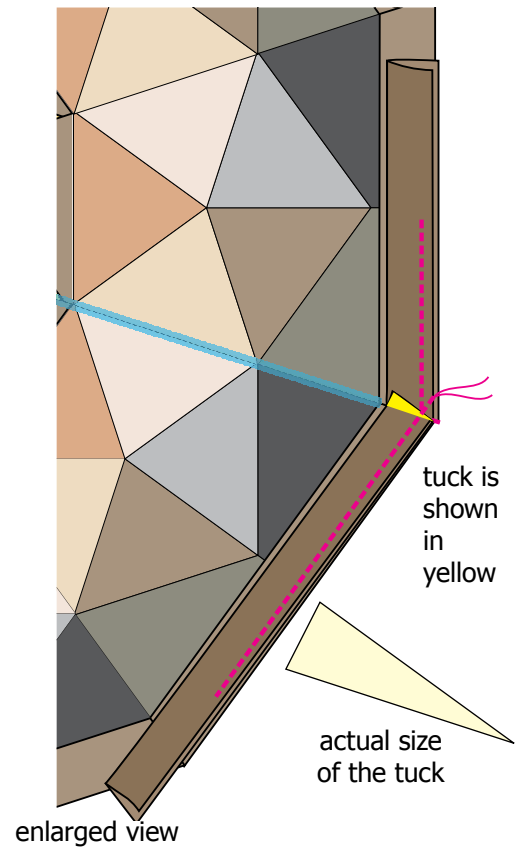
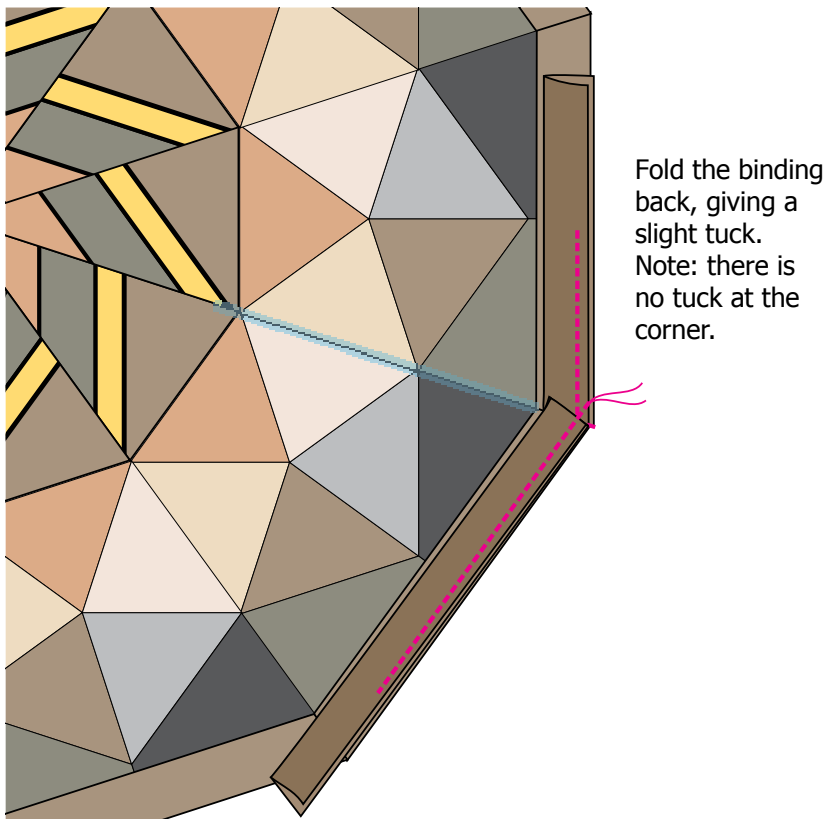
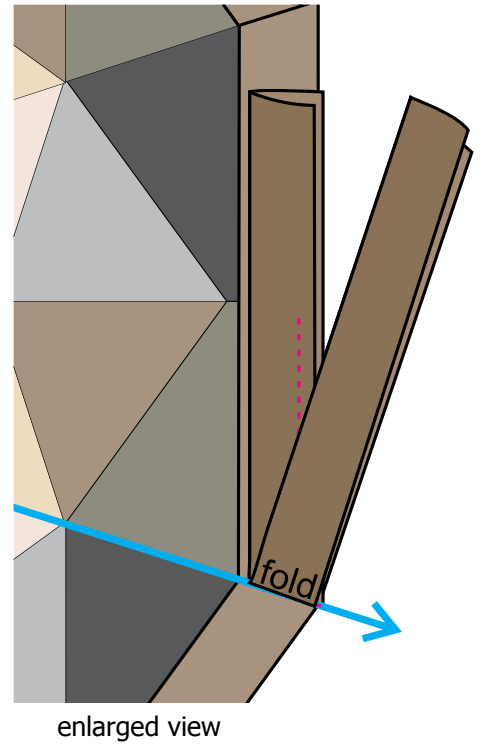
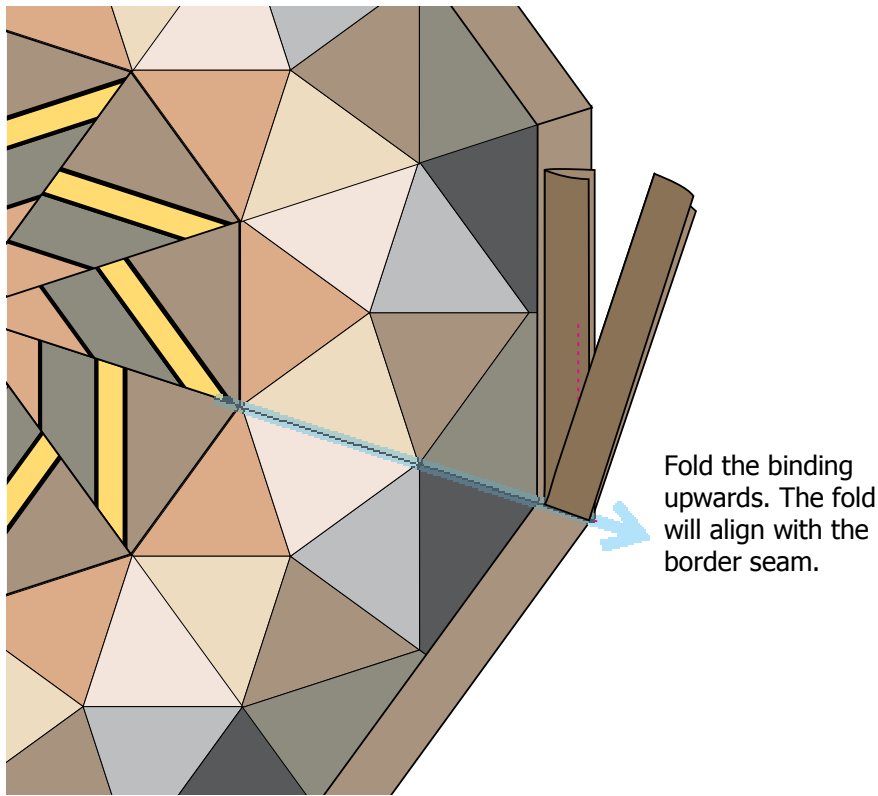

When you wrap the binding to the back, be sure the fold at the corners is aligned to the border seam.