A top-down view of a desk with a laptop, a coffee cup, a croissant, blueberries, and a succulent.

VIRTUAL
Breakfast
Club

Hand Quilting By Machine

Brought to you by:

MATERIAL Girls
Quilt Boutique

6750B Crain Highway LaPlata, Maryland 20646
301.392.9575 www.materialgirlsqilt.com

How is that possible?

Get the look of hand-quilting without all the handwork - using your sewing machine! The hand-look quilting stitch or mock quilting stitch creates the look of a hand-sewn running stitch without all the work.



The Secret?

A special stitch and the right thread on top!

Invisible Thread

OR

60wt thread - 80wt thread

(Bottom Line is what I will be using today on the top of my machine)

Setting up for Mock Hand Quilting

- Wind the bobbin with the thread you want to see as the quilting stitch. Thread the bobbin normally.
- Thread the needle with monofilament thread or 60wt thread.
 - Be sure you have the correction size needle and type of needle for the thread you are using.
 - If using monofilament - choose clear or smoke depending on the fabric you are stitching on.
- Select the Quilt Menu
 - On most BERNINA models these stitches are found in decorative menu #1300 (Quilting Stitches)

BERNINA®
B 880

4.75

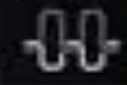

0.0

2.50

1C



50

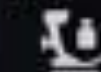

9mm

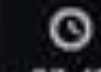
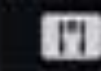

07:42



1324 1325 1326

1327 1328 1329

1330 1331 1332

1333 1334 1335

1 / 6

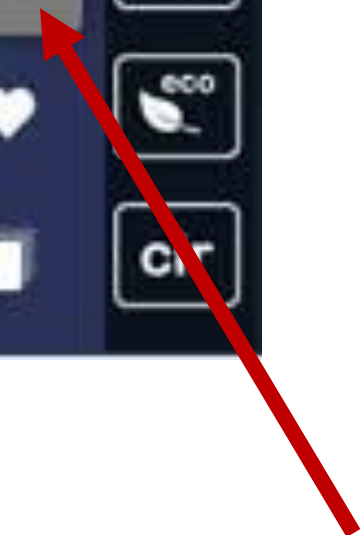
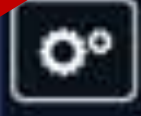

Available on most BERNINA machines

Machine Model	
BERNINA 8 and 7 Series Machines	# 1328
BERNINA 4 and 5 Series Machines	# 1304
BERNINA 335 / 325 / 350	# 106 / # 38 / # 77
Arista 730/200/640/630	# 328
Aurora 440/ 430	# 49 / # 40
Activa 240/230/220	# 40 / # 24 / # 27
BERNETTE 7 Series	# 1004
BERNINA 530/550/560/580	# 1328
Activa 135/145	# 20

If you don't see your machine listed on the left, look on your machine and/or machine stitch cards for this stitch image. They also usually list the hand look quilting stitch technique in the owner's manual and list the stitch number.



Handlook quilting stitch

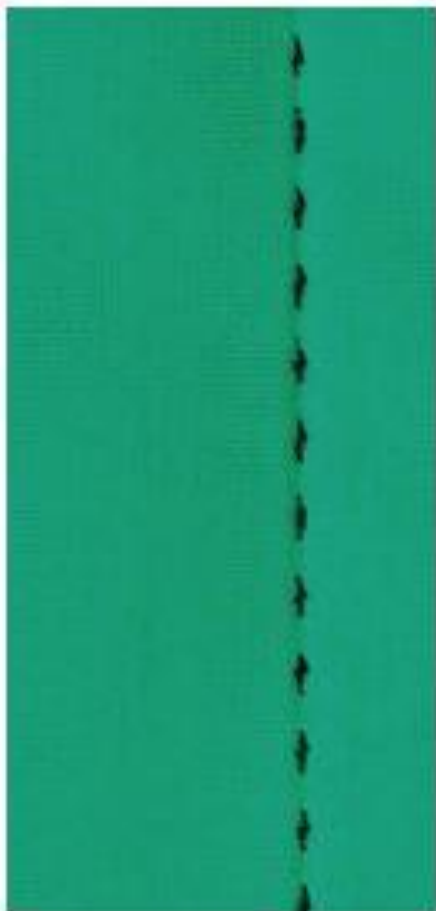

Reverse pattern sole no. 1

Handlook quilting stitch

Suitable for all fabrics and work which should look «hand sewn».

Test-sewing

- the bobbin thread must come through to the right side
- 1 stitch is visible (bobbin thread)
- 1 stitch is invisible (monofilament) = hand-look effect

Upper thread tension

Depending on the fabric = increase the tension (6-9).

Balance

Adjust stitch with the Balance if necessary.



Perfect corners

- activate Pattern end and Needle stop down and pivot the work
- when pivoting make sure that the fabric does not become distorted

Monofilament breaks

- sew more slowly

Tension adjustment

On machines with self-adjusting tension, you will notice that the upper tension increases.

This will be the starting point but will probably need increased.



Tension adjustment

For machines with manual tension, you will need to increase the upper tension beginning at approximately 4.5.

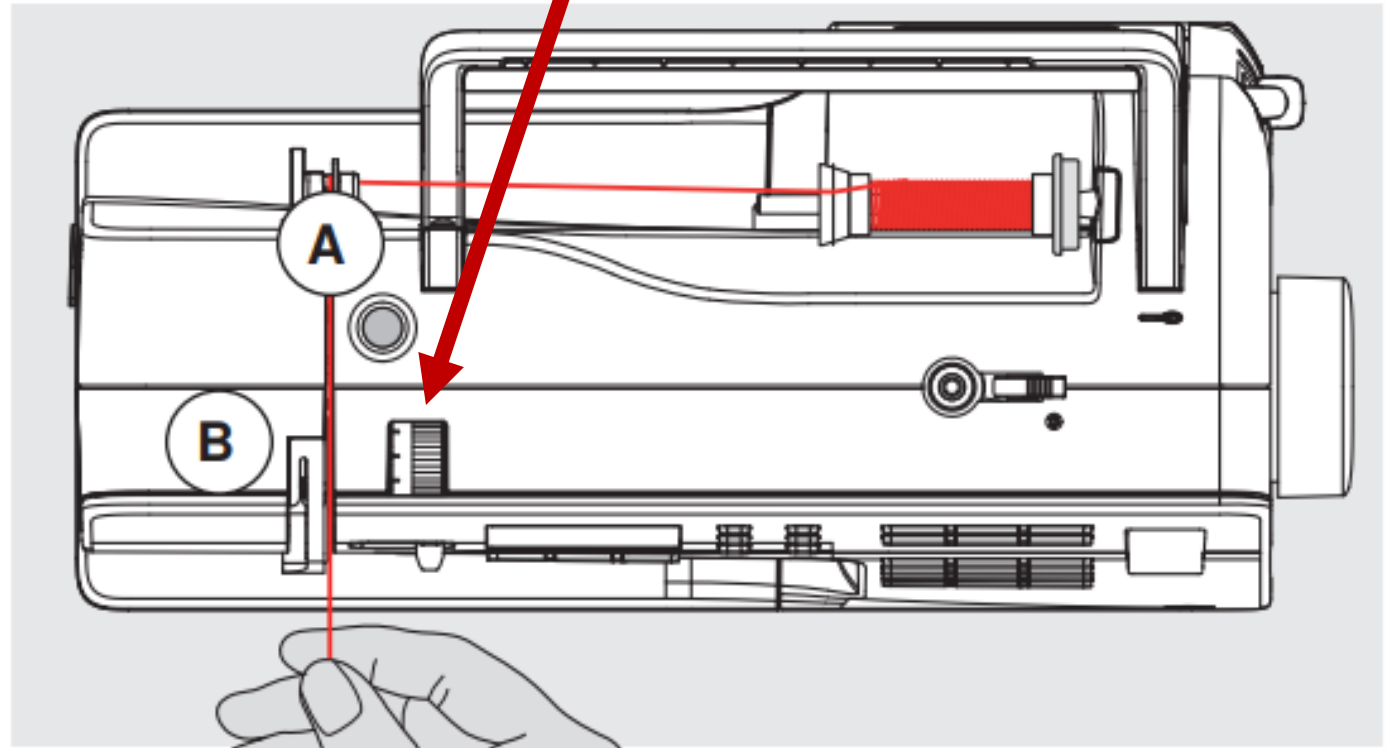
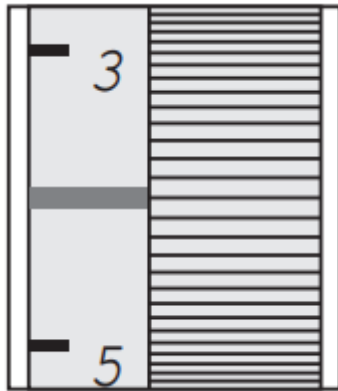



Presser feet options

- You can use any presser foot that allows a straight stitch. This technique/stitch only works with a straight stitch.
- If you want curves think about using Foot #55 or #83 if you want complete circles

LET'S SEW

- Sew several inches as it takes a little bit for the machine to start forming the stitch. It is good to hold both upper and lower threads in your hands to get started to help this stitch to begin to form right away.
 - The tighter upper tension on the thread pulls the bobbin thread up to the surface, which is why you want the thread you want as the visible quilt stitch in the bobbin. Be careful about tightening the tension too much as some threads may break easily under such high tension.
- Stitch #1328 (or the any of the stitch numbers listed on the chart) makes 6 stitches per inch. Depending on the machine you are using, there may be additional mock quilting stitches with 8 and 10 stitches per inch. There is even an irregular stitch in case you do not want perfect stitches!



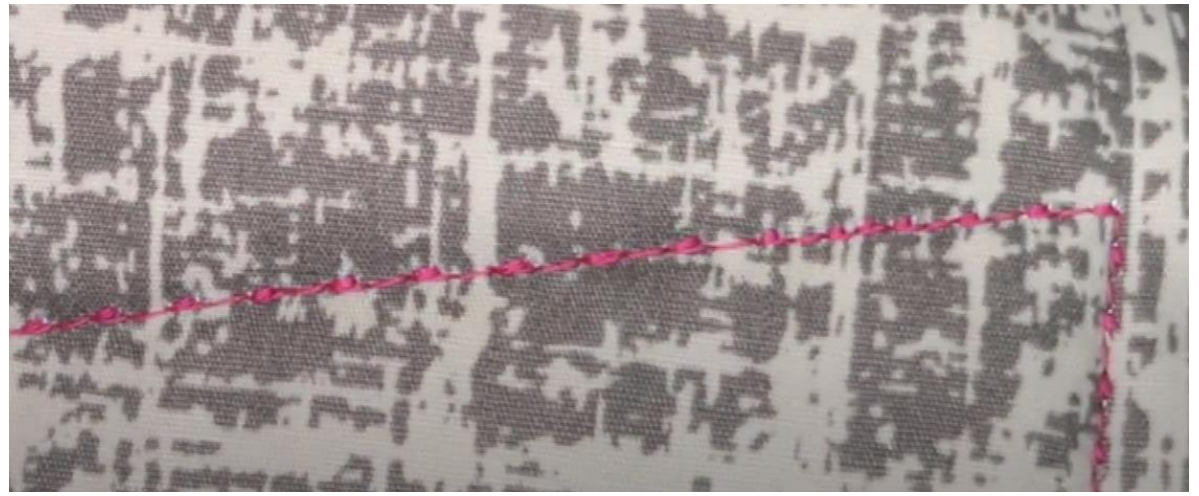
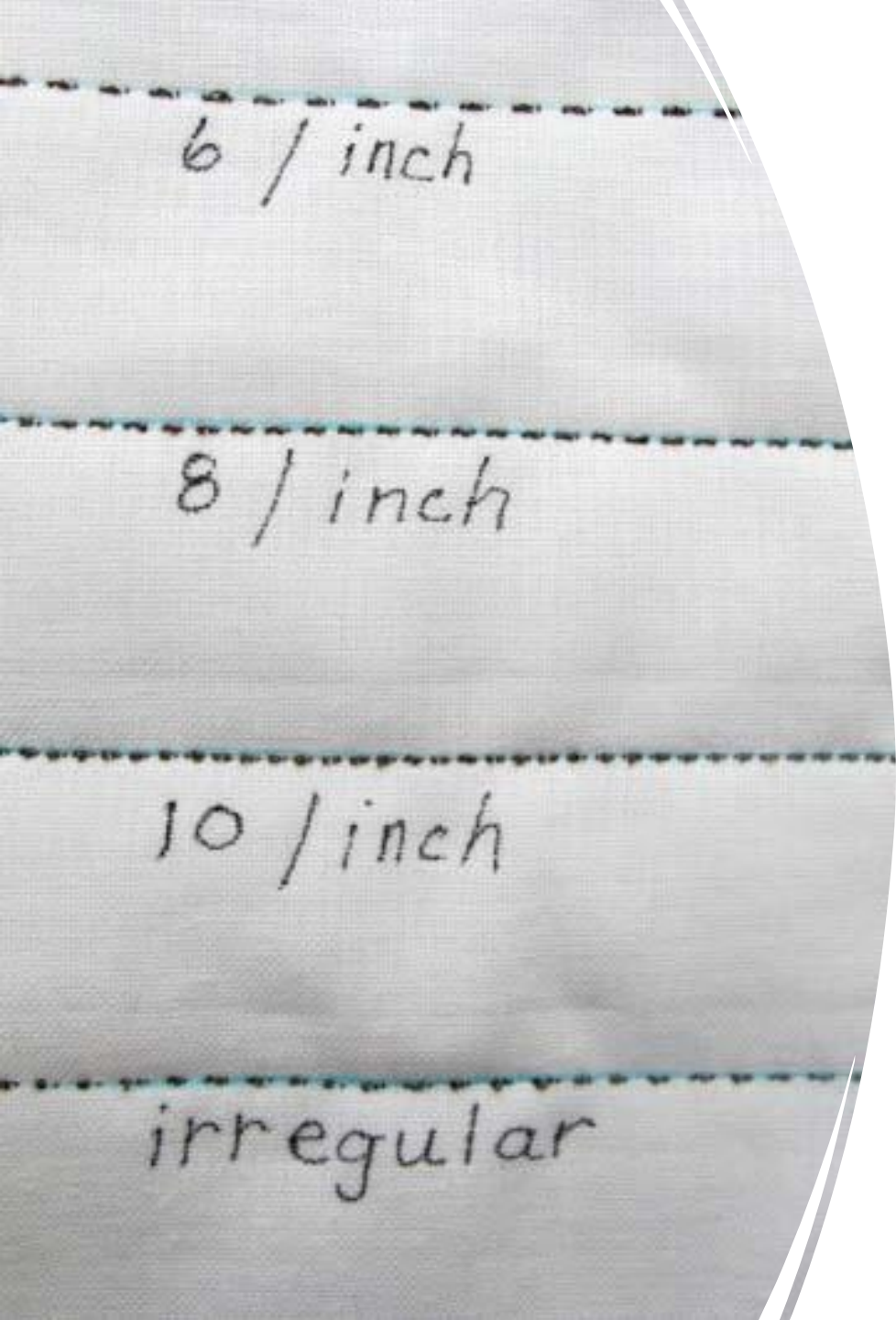

The wrong side of the stitch

examples

<https://weallsew.com/quilting-basics-is-it-hand-quilted-or-machine-quilted/>

TEST TEST TEST

- This technique will require some testing and alterations to get the stitch to form properly based on thread choices, fabric, and batting.
- If the stitch is still not forming properly, you may need to look at adjusting bobbin tension. This is something that I would highly recommend a completely different bobbin case for. You DO NOT want to mess with the tension on your bobbin case that you do regular sewing with. The one exception to the rule on this is the BERNINA 8 series machines.