



moda

Be My Neighbor

Block 12

9" x 18" finished

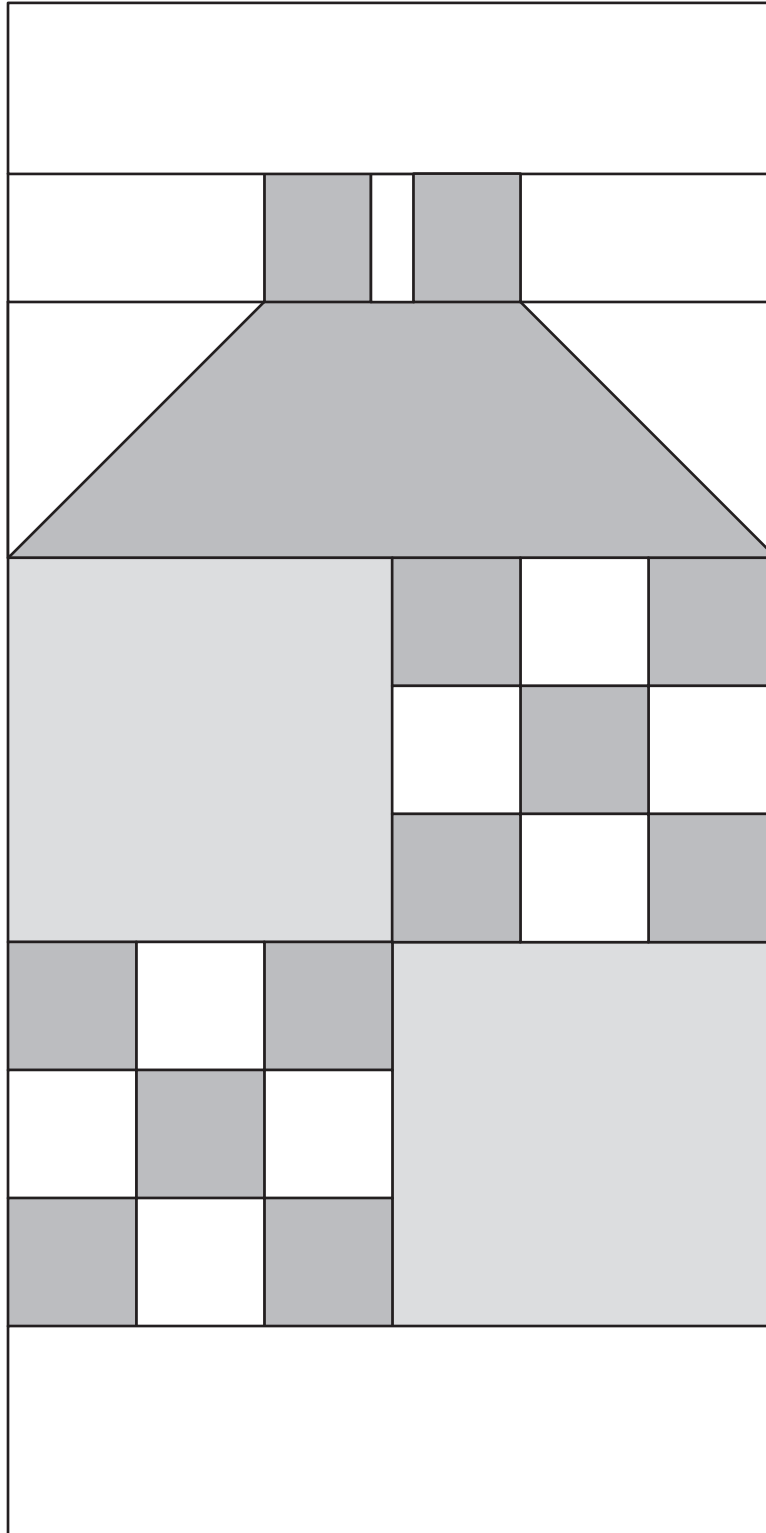

General Information

- These are very scrappy blocks. Mix your favorite Moda prints to create your colorful neighborhood!
- Share your progress and final quilt at #BeMyNeighbor. We love to see your results!!!

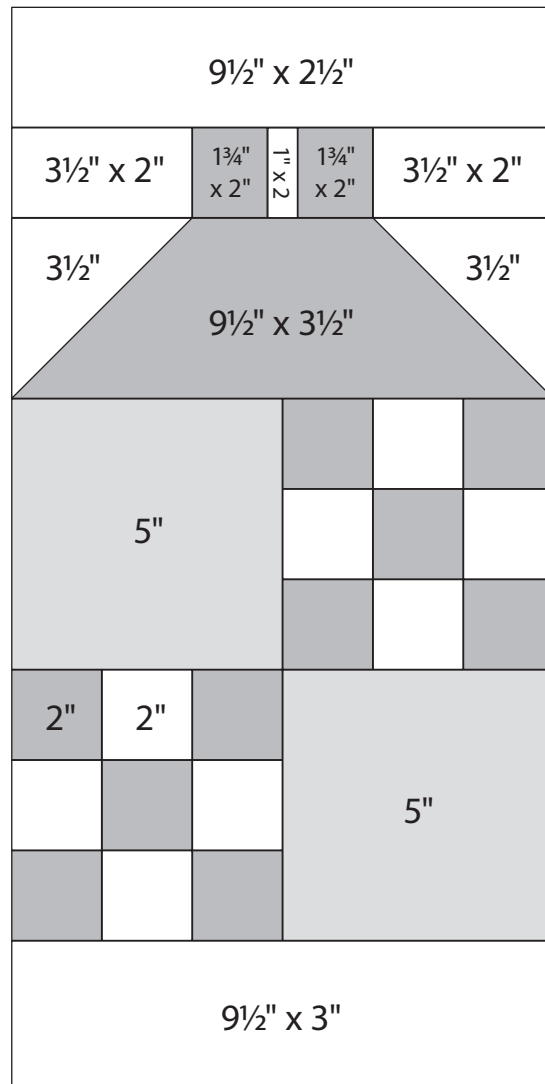

Block 12
9 1/2" x 18 1/2" unfinished

Cutting

House Roof

1-9 1/2" x 3 1/2" rectangle

House

2-5" squares

Chimneys

2-1 3/4" x 2" rectangles

Nine-Patches (dark/medium)

10-2" squares

Background

1-9 1/2" x 3" rectangle

1-9 1/2" x 2 1/2" rectangle

2-3 1/2" squares

2-3 1/2" x 2" rectangles

8-2" squares

1-1" x 2" rectangle



Be My Neighbor

Block 12 is 9" x 18" finished.

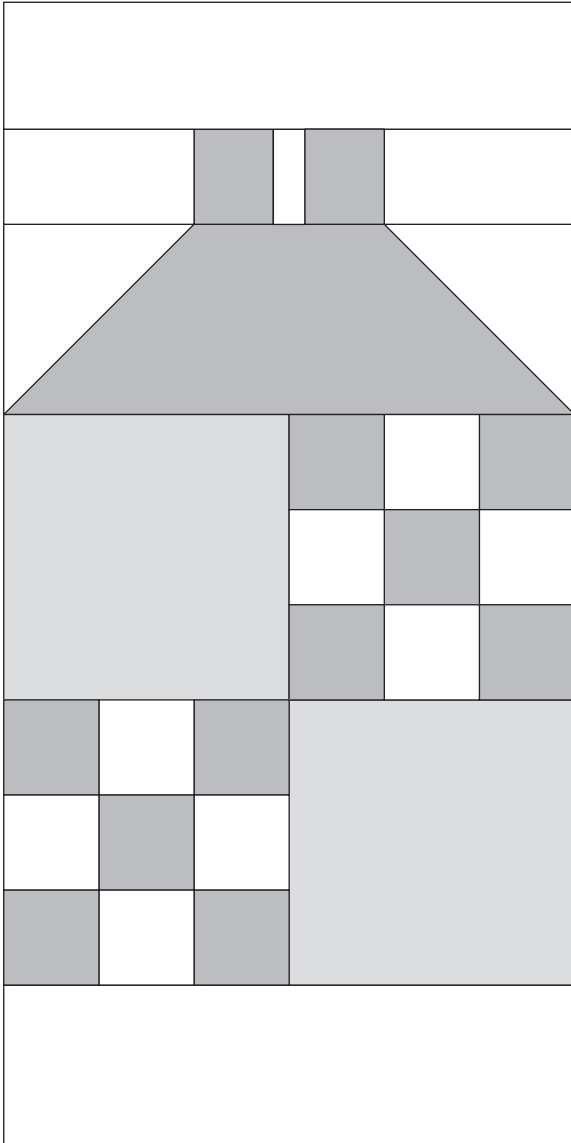

moda

Construction

Use 1/4" seams. Press in the direction of the arrows in the diagrams.

1 Assemble the chimneys as shown.

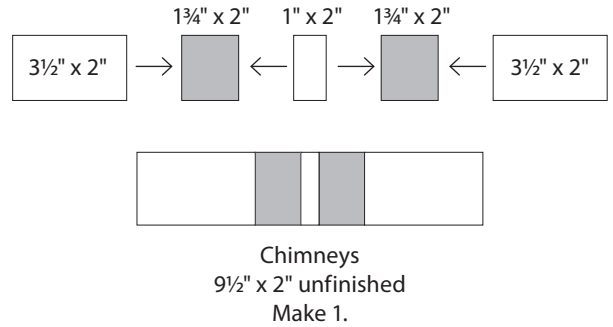

2 House Roof

Draw a diagonal line from corner to corner on the wrong side of 2-3 1/2" background squares. Layer a 3 1/2" marked background square, right sides together, on 1-9 1/2" x 3 1/2" roof rectangle as shown. Sew on the diagonal line. Trim 1/4" from the sewn line. Press to reveal the triangle. Repeat on the the opposite end of the same rectangle. Make 1.

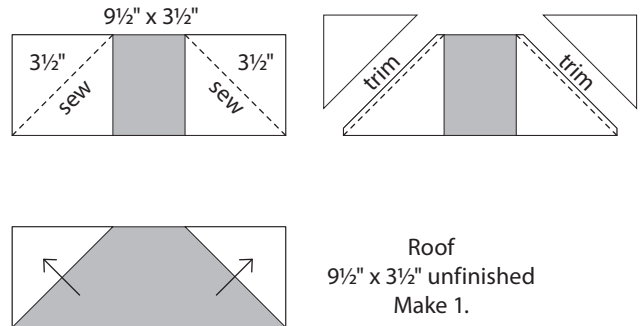

3 Nine-Patch

Arrange 5-2" dark/medium squares and 4-2" background squares in 3 rows as shown. Join the rows. Make 2 nine-patches.

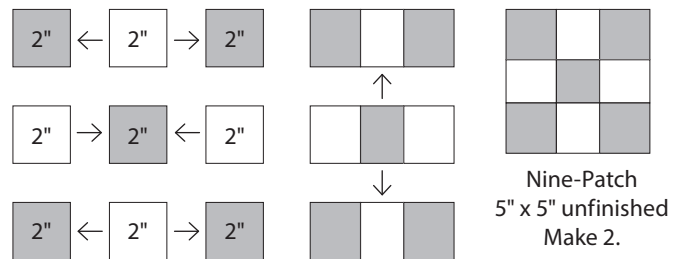

4 Assemble the block as shown.

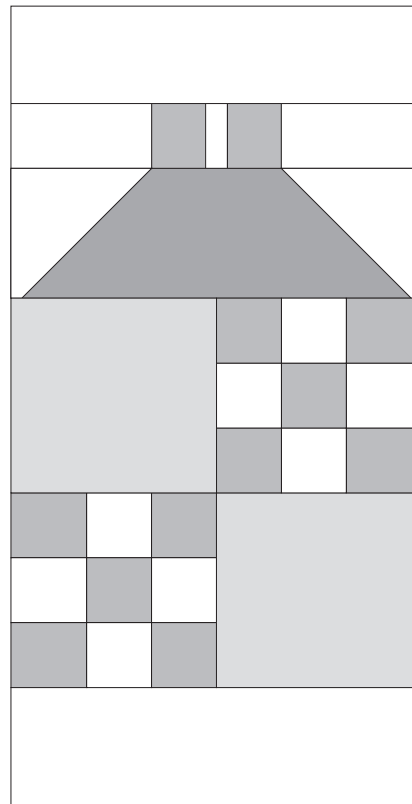
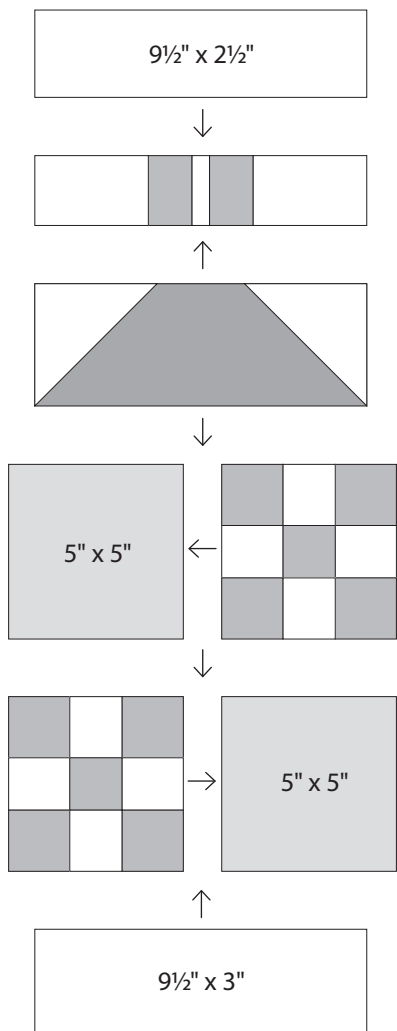

Block 12
 $9\frac{1}{2}'' \times 18\frac{1}{2}''$ unfinished

moda