

Desert Moons

FABRICS BY LONNI ROSSI



Suzani Triptych quilt design by **Lonni Rossi**

Quilt Size: 42" x 60"

andoverfabrics.com

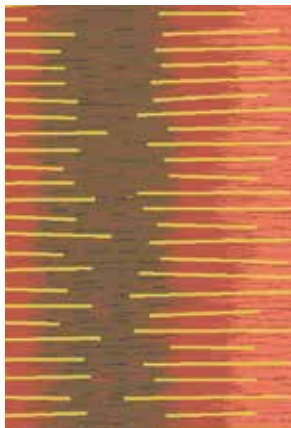

About Desert Moons

Desert Moons was inspired by the Suzani textiles from Central Asia. Historic hand embroidered motifs found in Suzanis are the tulip, teardrop and sunburst, and colors are vibrant reds, blacks, golds and blues. Lonni has designed a unique 36" wide panel, with three companion motifs, all sprinkled with her signature gold and silver metallic accents.

andover



makower uk
The Henley Studio

Free Pattern Download Available

1384 Broadway New York, NY 10018
Tel. (800) 223-5678 • andoverfabrics.com

Suzani Triptych Quilt



Introducing Andover Fabrics new collection: **DESERT MOONS** by Lonni Rossi

Quilt designed by Lonni Rossi

Quilt finishes 42" x 60"

The central focus of this sumptuous wall-size quilt is the symmetrical designs within each lavish circle. The dramatic color scheme moves from very light to deepest dark. The quilt goes together quickly and easily, so you may have time to make more than one.

Cutting Directions

Note: Read assembly directions before cutting patches. All measurements are cut sizes and include 1/4" seam allowances. WOF designates the width of fabric from selvedge to selvedge (approximately 43" wide).

3 Fabric A's

From each: Fussy-cut (1) strip 11" x 42 1/2"

Fabric B

Cut (2) strips 2 1/2" x 42 1/2", cut crosswise

Fabric C

Cut (2) rectangles 9 1/2" x 11"

Fabric D

Cut (4) rectangles 6 1/4" x 11", cut crosswise

Fabric E

Fussy-cut (2) strips 3 3/4" x 22 1/2", cut crosswise

Fabric F

Cut (8) strips 3 3/4" x 16 1/4"
Cut (4) rectangles 2 1/2" x 6 1/4"

Backing

Cut (2) panels 34" x 50", pieced to fit quilt top with overlap on all sides

For *invisible* binding:

Cut (2) strips 3 1/2" x width of quilt raw edge to raw edge
Cut (2) strips 3 1/2" x length of quilt raw edge to raw edge

Binding (opt.)

Cut (6) strips 2 1/2" x WOF for *traditional* binding

Fabric Requirements

		Yardage	Fabric	
3 Fabric A's	setting	1/3 yard each	7722-MB 7722-MR 7722-MY	
	Fabric B	setting	1/4 yard	7723-MR
	Fabric C	setting	3/8 yard	7724-MY
Fabric D	setting	3/8 yard	7725-MBC	
Fabric E	setting	1/4 yard	7725-MR	
Fabric F	setting	1/2 yard	5468-DK	
Binding	(optional)	1/2 yard	5468-DK (suggested)	
*Backing		3 1/2 yards	7723-MYC	

Making the Quilt

1. Referring to the quilt photograph, fussy-cut an 11 x 42 1/2" strip from each Fabric A. Arrange all patches and strips on a design wall or large flat surface.
2. Arrange the patches into 7 vertical columns. Join patches to make partial columns 1, 2, and 3. Sew the 3 partial columns together, and then add Fabric F 3 3/4" x 16 1/4" rectangles to the top and bottom. Likewise, join columns 5, 6, and 7 before adding Fabric F rectangles to the top and bottom. Join Fabric A and Fabric C patches to make the center column. Sew it between the larger side pieced units.

Finishing the Quilt

3. Layer the quilt with batting and backing and baste. Quilt in the ditch around strips and block patches. Quilt around the printed moons.
4. Follow the directions for Lonni's invisible binding. If you prefer traditional binding, do not cut the strips listed for cutting the backing fabric. Bind the quilt to finish.

Suzani Triptych Quilt

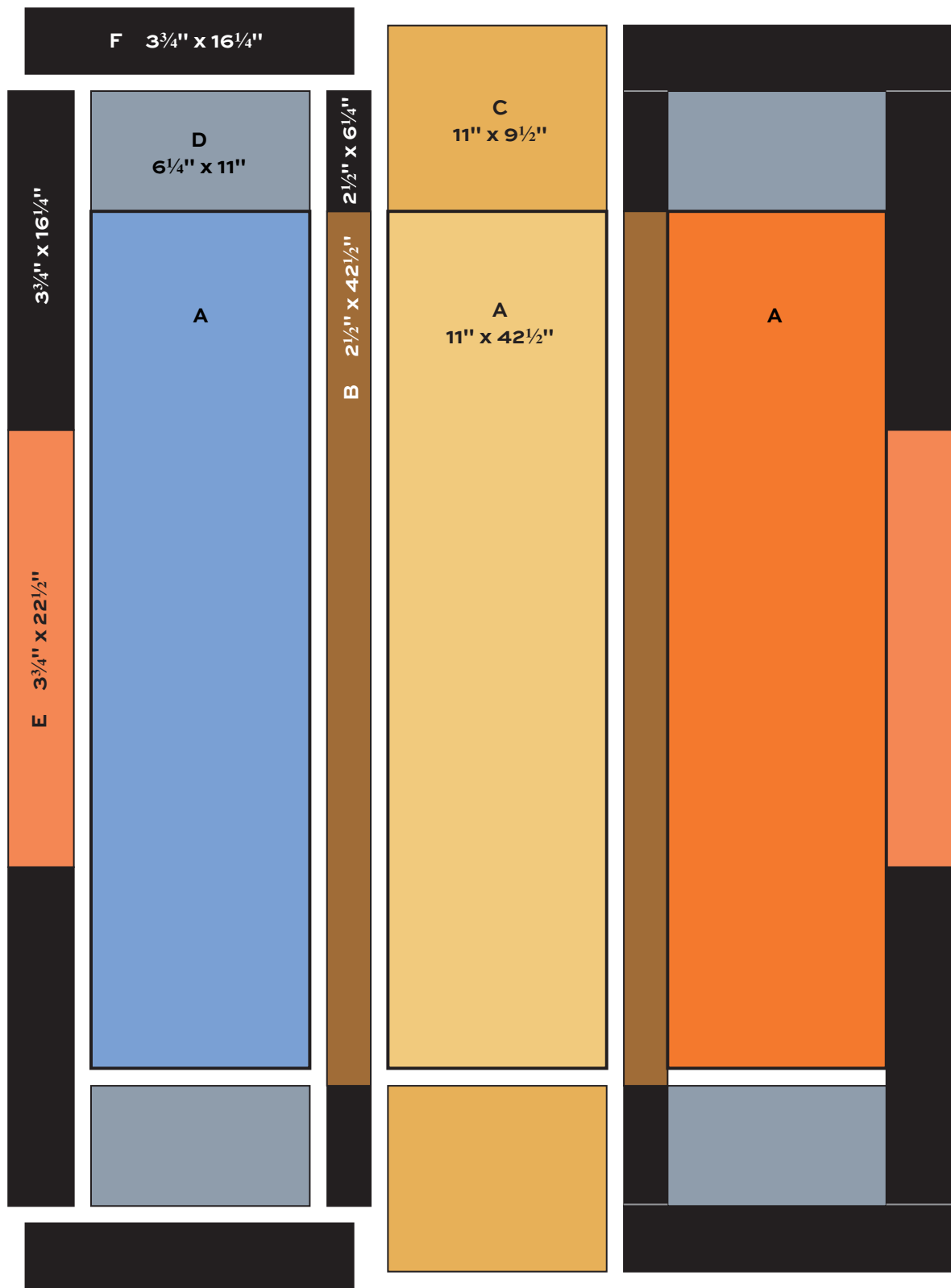

Quilt Diagram

Suzani Triptych Quilt

Invisible Binding

These directions are for binding that doesn't show on the front of the quilt. Strips of fabric are stitched around the quilt to make a facing with mitered corners. The entire facing is turned to the back of the quilt. These directions work for any quilt when you want the design to be uninterrupted all the way to the edge of the quilt.

Step 1

When you have finished quilting, trim the edges of the quilt so all sides are straight and the corners are square.

Step 2

Measure through the center of your quilt from the top raw edge to the bottom raw edge. Note this measurement. It will be the length of your side strips. Similarly, measure from side to side across the center of the quilt. This will be the length of your top and bottom strips. Cut the number of $3\frac{1}{2}$ "-wide strips needed to construct the facing strips. Piece them with diagonal seams as necessary to make 2 side strips and 2 top/bottom strips the exact length needed for your quilt.

Step 3

Press $\frac{1}{2}$ " to the wrong side on one long edge of each strip.

Step 4

Lay quilt face up on a table. Right sides together, align the unpressed edge of one strip with the corresponding edge of the quilt top, matching centers. Starting at the center, pin the binding to the quilt to within 6 inches of each corner. Continue in this manner until you have pinned the binding strips to all four edges of the quilt top.

Step 5

Using a 45° triangle ruler, mark the sewing line for the miter at the end of each strip, remembering to add the seam allowance. With right sides together, pin corners and sew the miters without removing the pinned binding from the quilt. Trim off the excess fabric, leaving a $\frac{1}{4}$ " seam allowance.

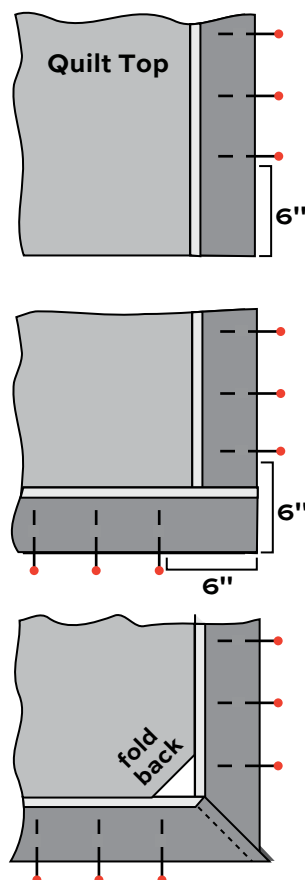

Step 6

Finger press the seam allowances open and finish pinning the corners to the quilt. Using a walking foot, sew the binding to the quilt using a $\frac{3}{8}$ " seam all the way around all four sides. Trim the seam allowances at the corners.

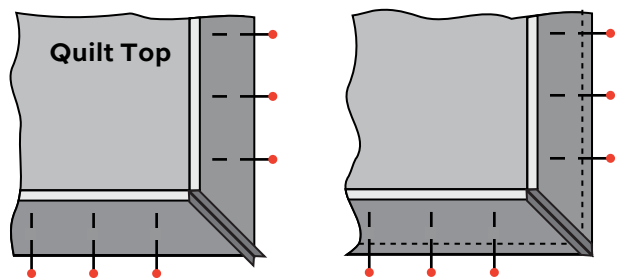

Step 7

Turn the binding to the back of the quilt, making sure the corners are fully turned to a nice crisp point.

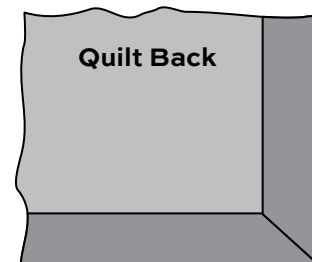

Step 8

Steam press so the edge is straight and the quilt lies flat. Whip stitch the folded edge to back of quilt by hand, being careful not to let any stitches show through to the front of the quilt.

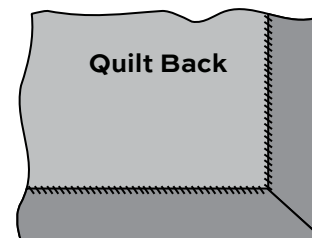

Desert Moons

BY LONNI ROSSI

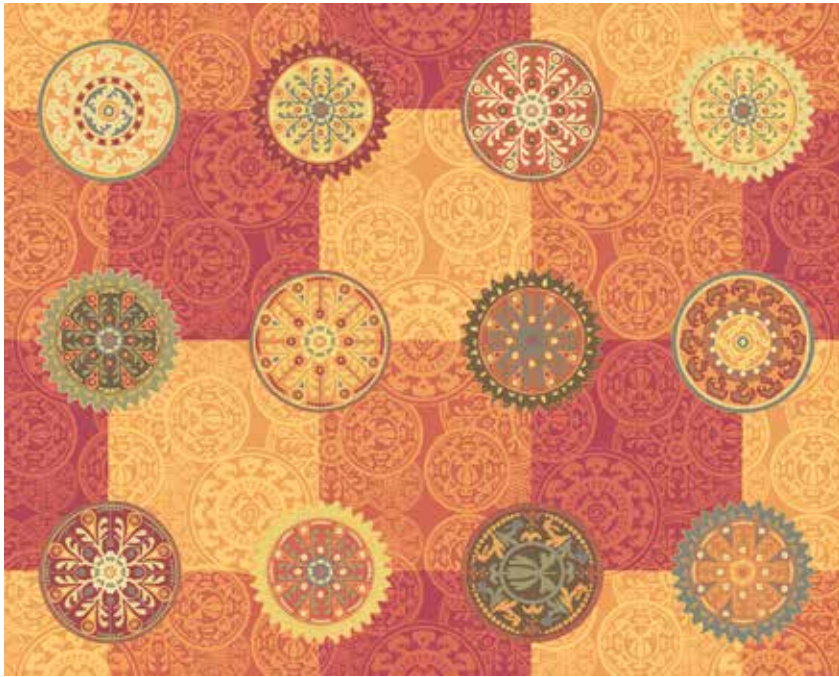

7722-MR*

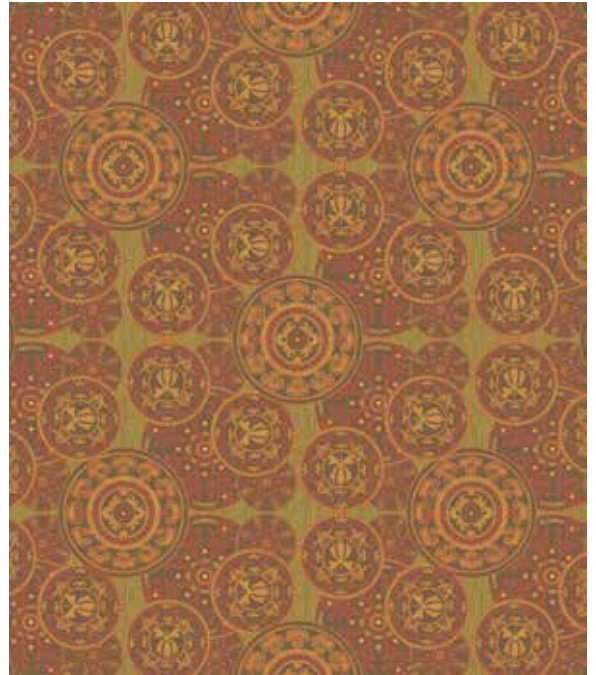

7723-MR*



7724-MR



7725-MR*

Blend with fabrics from **Raindrops** by Lonni Rossi



5468-O



5468-R

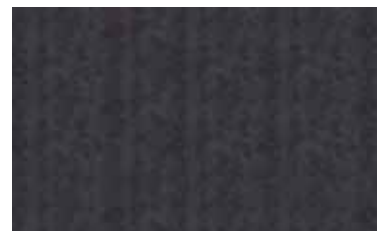

5468-DK*

All fabrics are used in quilt pattern. Fabrics shown are 10% of actual size.

andover



makower uk
The Hanley Studio

Free Pattern Download Available

1384 Broadway New York, NY 10018
Tel. (800) 223-5678 • andoverfabrics.com



7722-MY*



7723-MYC*

Blend with fabrics
from **Raindrops**
by Lonni Rossi



5468-Y1



5468-C1



7724-MY*



7725-MY



7722-MB*

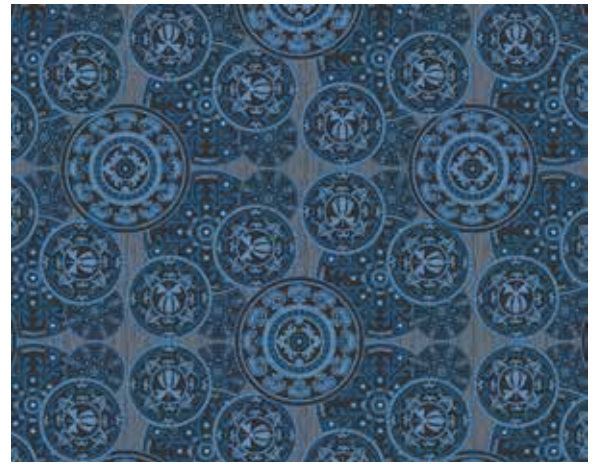

7723-MB

Blend with fabrics
from **Raindrops**
by Lonni Rossi



5468-B



5468-B2



7724-MB



7725-MBC*

Desert Moons

BY LONNI ROSSI

andover : makower uk
The Henley Studio