



DID YOU KNOW?

- As “owner-builder” you are the responsible party of record on such a permit. If your work is being performed by a contractor, you may protect yourself from possible liability if the contractor applies for the proper permit in his or her name
- If you plan to do your own work, including all of the trade work then you may apply for the permit
- Frequent practices of unlicensed contractors is to secure an “owner-builder” building and trades permits, erroneously implying that the property owner is providing his or her own labor and material personally
- It would benefit you to hire a licensed contractor to perform the trade work
- Permits are valid for work to begin within six months

Why Do I need a Permit?

There are many important reasons to obtain building permits and to have inspections performed for your construction project.

Protects property values

Your home is typically your largest investment. If your construction project does not comply with the building codes, your investment could lose value. If others in your neighborhood make unsafe or substandard changes to their homes, it could lower the resale values for the entire community.

Saves Money

Homeowners insurance policies may not pay for damages caused by work done without permits and inspections.

Makes Selling Property Easier

Listing associations require owners to disclose any home improvements or repairs and if permits were obtained. Many financial institutions will not finance a purchase without proof of a final inspection. If you decide to sell a home or building that has had modifications without a permit, you may be required to tear down the addition, leave it unoccupied or do costly repairs.

Improves safety

Your permit allows the building department to inspect for potential hazards and unsafe construction. By ensuring your project meets the minimum building code standards of safety, the building department can reduce the risk of fire, structural collapse and other issues that might result in costly repairs, injuries and even death. Inspections complement the contractor’s experience and act as a system of checks and balances resulting in a safer project.

It’s the Law

Permits are required by Ordinance. Work without a permit may be subject to removal or other costly remedies.

The purpose of this guide is to assist you in the permitting process. This handout is intended to cover information for a basic plan submittal and typical project under the building codes. It is not intended to cover all circumstances. Depending on the scope and complexity of your project, additional information may be required. Discuss your project with city staff to determine if it is subject to additional requirements.

What do I need in order to apply for a building permit?

The following must be submitted:

<input type="checkbox"/> Site Plan	Page 2
<input type="checkbox"/> House & Post Attachment	Page 3
<input type="checkbox"/> Footings	Page 4
<input type="checkbox"/> Pergola information	Page 4
<input type="checkbox"/> Cross-Section Patio Cover	Page 5
<input type="checkbox"/> Permit Application	



What is a Site Plan?

A site plan is a detailed drawing of your property, also known as a survey of your land. These are usually drawn by a land surveyor. The site plan will show the dimensions of your project and its relationship to existing setbacks, easements, utilities, other structures on the property, and distance to your property lines. If your project will require moving any utilities (gas, water, sewer/septic, electric, etc.), show where those utilities will be relocated.

What is REQUIRED for a Permit?

- Provide copies of the SITE PLAN

Notes:

1. Structures must meet zoning requirements and may not be permitted to be built over setback lines, easements, or property lines
2. A survey from a registered land surveyor will be required if your project is located in a protected area
3. An as-built survey may be required if the structure is proposed within 12" of a required minimum setback
4. Check with your municipality's zoning department for any location restrictions
5. If you do not know the location of your utilities, contact the Utility Notification Center. Remember to ask them about the cost of this service.

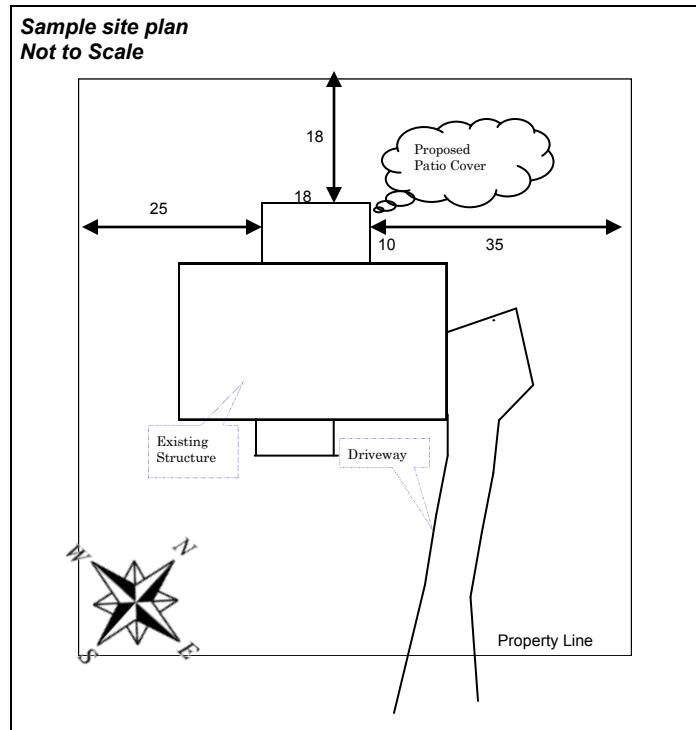

Construction Details

What is REQUIRED for a Permit?

- Provide copies of a CONSTRUCTION PLAN (cross-sectional drawing showing):
 - footing dimensions
 - column dimensions
 - attachment details
 - Spans of rafters & beams—roof pitch/details, and dimensions of all material

NOTES:

1. All lumber in contact with the ground or concrete shall be treated or rated for this use.
2. All connectors shall use nails for attachment

3. All screws or nails shall be hot dipped galvanized or stainless steel, and nails shall be ring-shanked or annular grooved
4. Patio Covers are limited to 12' in height maximum.
5. Conditions which do not meet these details may require a more detailed plan submission, up to and including engineer-stamped plans.
6. Patio Covers/Carports shall be constructed in accordance with the International Residential Code

Tips on hiring contractors

- ◆ Hire only licensed contractors
- ◆ Get at least 3 bids
- ◆ Get 3 references, and ask to see a project
- ◆ Get it in writing - but before you sign the contract, make sure you completely understand
- ◆ Don't make final payment until you have a Certificate of Completion (CC) and you are satisfied
- ◆ **Have the contractor apply for the required permits**



Construction Details: Attaching to the House

Correctly attaching your new patio cover or carport to your existing home is critical to preventing collapses. A common issue that can cause problems are patio covers or carports that pull away from homes because of missing or inadequate house attachments.

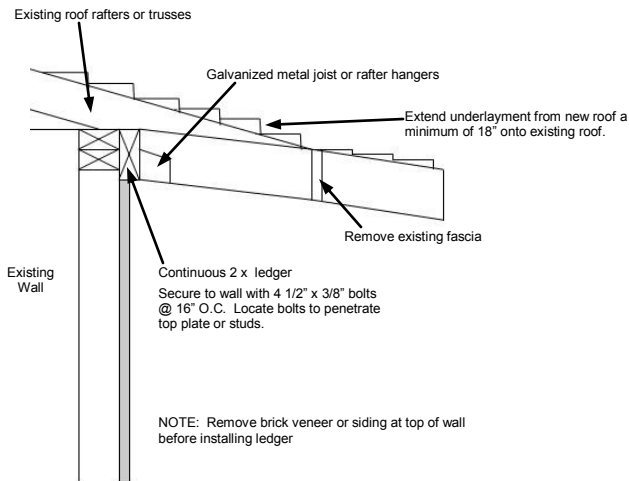

Detail A

Sample attachment details

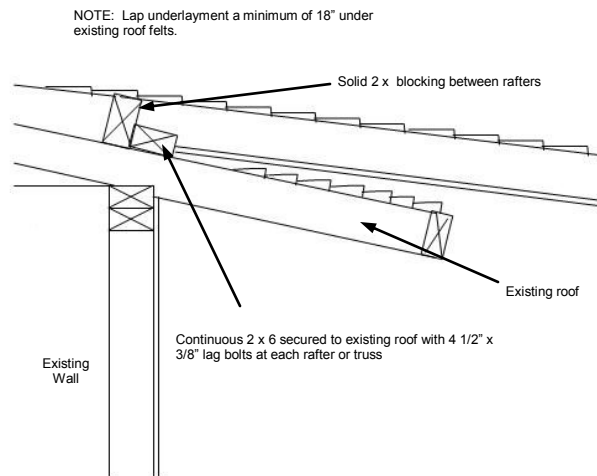

Detail B

Construction Details: Post Attachment

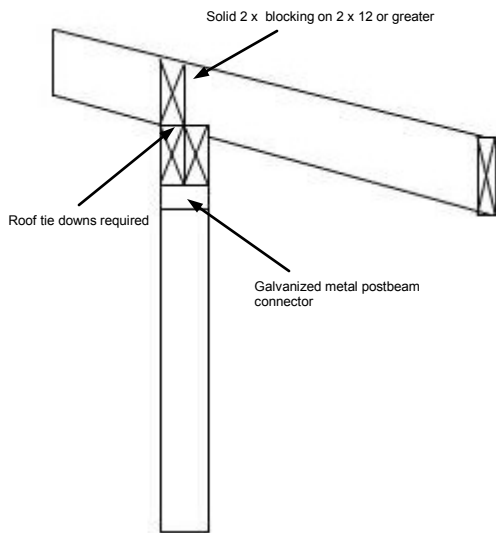

Standard Post Attachment

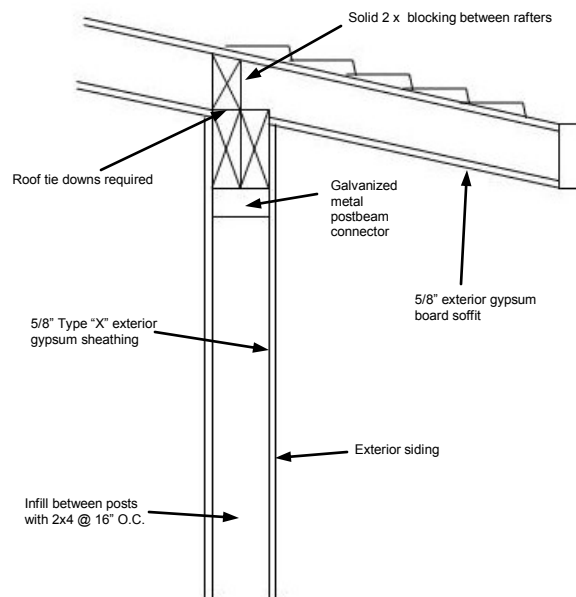

One-Hour Wall Post Attachment

Design loads vary due to geographic location. Check with your local SAFEbuilt office for the applied roof load in your area:

- Conventional framing must show all dimensions in submitted plans in order to verify compliance with adopted building code.
- Any truss system shall be designed & approved by the truss manufacturer's design professional. Stamped truss drawings are required on site for all inspections.



REMINDER:

Permits are only issued after plan review. The time required to conduct this review will depend on the completeness of the information received in the plans.

Construction Details: Footing Requirements

Standard Footing Detail

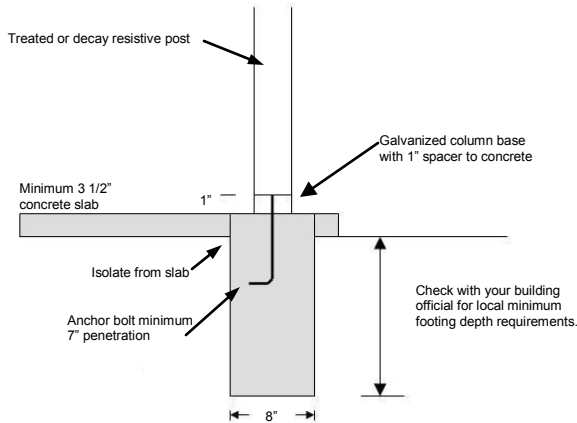

The building code lists several requirements for footings based on use of the patio cover/carport and snow load conditions. At a minimum, footings shall be at least down to the frost depth for your location. Check with the building department for specific depths required. Additionally, the posts must be attached to the footing according to code to prevent lateral movement and uplift (wind and cantilevered forces). Posts must also be either a natural decay-resistant or preservative-treated wood and supported by a metal pedestal projecting 1" above the concrete and 6" above exposed earth to prevent moisture rot.

One-Hour Wall Detail

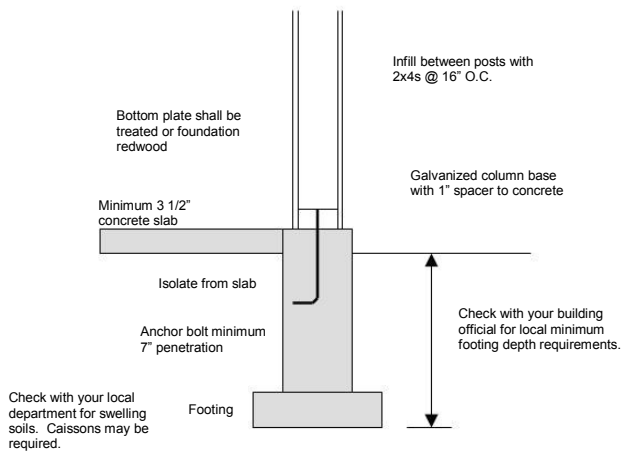

PERGOLAS

Pergolas are typically not designed to require a roof load to transfer to the supporting piers or footings, thus not requiring the construction to be designed for normal roof/snow loading. Check with your local municipality to see if they require a permit for these type of assemblies.

If a permit is required by your jurisdiction, please show size and location of the proposed pergola on a plot plan and include distances to the property line and any other structures on the property.

Additional Information

What will the building inspector look at?

A typical patio cover/carport project will require the following inspections:

1. **Footings:** Footing inspections shall be made after holes are dug, any reinforcing steel is in place/forms erected, and PRIOR to placing of concrete
2. **Framing Inspection:** Inspection of the roof, truss/ledger attachment, rafter/joists, beams and hangers **prior to** any finished ceiling being applied. If electric is being installed for the patio cover/carport, a rough electric inspection should be called at the same time as the framing inspection.
3. **Final:** Inspection made AFTER the patio cover is completed, including any final electrical.

Want to know more? Need more help?

We hope you found the information in this guide useful. If you have any questions, please feel free to contact us.

How do I schedule a required inspection?

Please call the inspection line listed on your permit card and leave all information requested in the message.

Cross-Section Patio Cover / Carport Plan

DIRECTIONS: Fill in the blanks with dimensions and material which will be used to build the structure—please PRINT legibly.

This patio cover/carport is within 5 feet of property line:

Yes No

If any of the sides of the carport/patio cover are closer than 5' to the property line, that side of the carport/patio cover must be enclosed with a solid 1-hour fire rated wall as shown in the construction details on pages 3 and 4. You must, however, keep at least 2 sides of a carport open to conform to the Building Code requirements. Zoning Approval is required.

Roof Covering _____ (ex. Class A 3-tab shingles)

Pitch _____ / _____ (ex. 4/12)

Underlayment _____ (ex. 2 layers of 15# felt)

Roof Sheathing _____ (ex. 15/32" 24-16 CDX Plywood)

** Roofing it to be installed per manufacturer's instructions, including low slope application and required inspections made.

