



moda

Be My Neighbor

Block 16

16½" x 18" finished

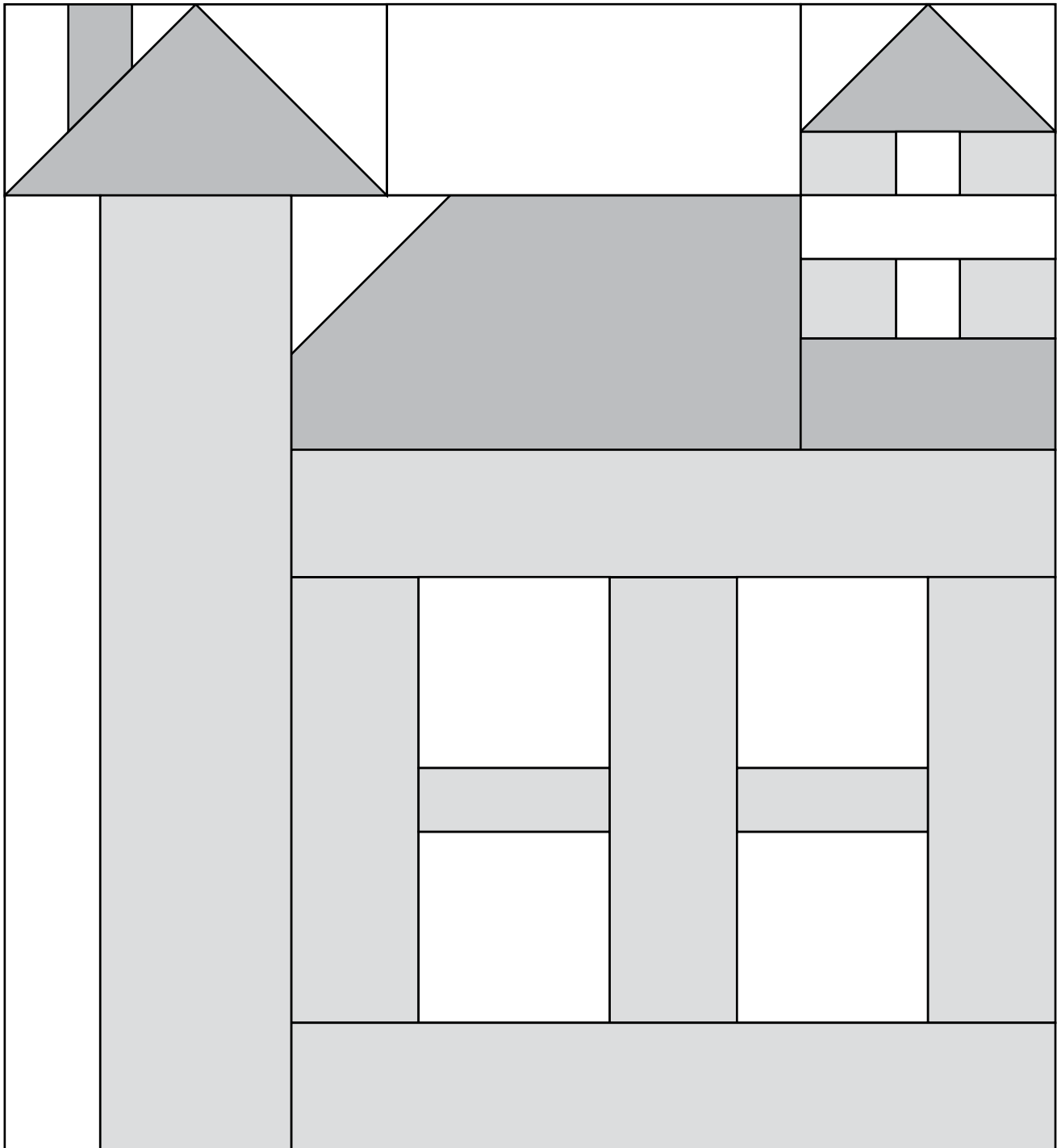

General Information

- These are very scrappy blocks. Mix your favorite Moda prints to create your colorful neighborhood!
- Share your progress and final quilt at #BeMyNeighbor. We love to see your results!!!

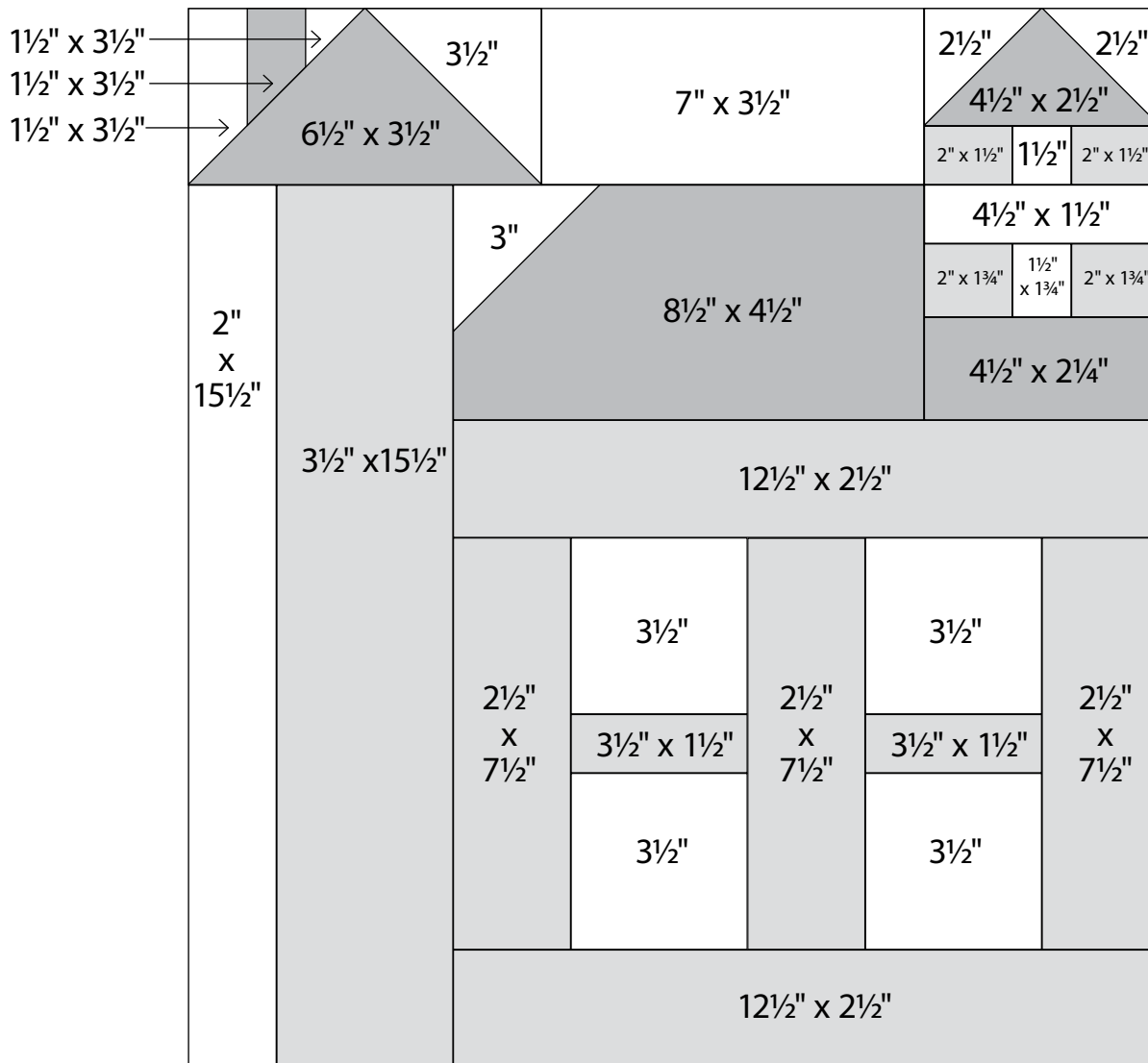

Block 16
17" x 18½" unfinished

Cutting

Roof and Chimney

- 1-8½" x 4½" rectangle
- 1-6½" x 3½" rectangle
- 1-4½" x 2¼" rectangle
- 1-1½" x 3½" rectangle

Roof small

- 1-4½" x 2½" rectangle

Tower

- 1-3½" x 15½" rectangle

Windows

- 4-3½" squares

Cross

- 1-4½" x 1½" rectangle
- 1-1½" x 1¾" rectangle
- 1-1½" square

House

- 2-12½" x 2½" rectangles
- 2-3½" x 1½" rectangles
- 3-2½" x 7½" rectangles
- 2-2" x 1¾" rectangles
- 2-2" x 1½" rectangles

Background

- 1-7" x 3½" rectangle
- 1-3½" square
- 1-3" square
- 2-2½" squares
- 1-2" x 15½" rectangle
- 2-1½" x 3½" rectangles



moda Be My Neighbor

Block 16 is 17" x 18" finished.

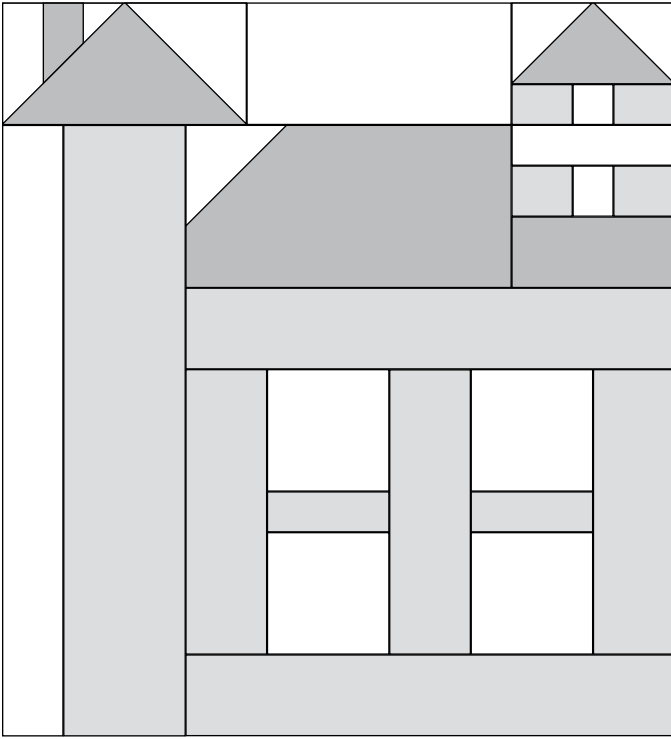

Construction

Use $\frac{1}{4}$ " seams. Press in the direction of the arrows in the diagrams.

1 Roof

Draw a diagonal line from corner to corner on the wrong side of 2- $2\frac{1}{2}$ " background squares. Layer a $2\frac{1}{2}$ " marked background square, right sides together, on 1- $4\frac{1}{2}$ " x $2\frac{1}{2}$ " roof rectangle as shown. Sew on the diagonal line. Trim $\frac{1}{4}$ " from the sewn line. Press to reveal the triangle. Repeat on the opposite end of the same rectangle. Make 1.

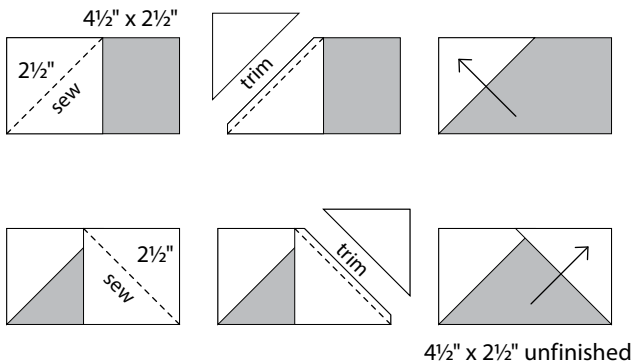

2 Roof with Chimney

(A) Join 2- $1\frac{1}{2}$ " x $3\frac{1}{2}$ " background strips and 1- $1\frac{1}{2}$ " x $3\frac{1}{2}$ " chimney strip as shown.

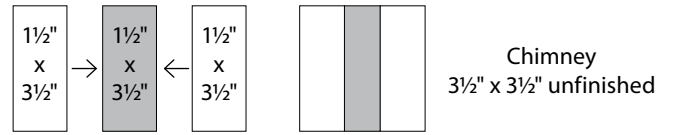

(B) Draw a diagonal line from corner to corner on the wrong side of the chimney and a $3\frac{1}{2}$ " background square as shown. Layer the marked chimney, right sides together, on a $6\frac{1}{2}$ " x $3\frac{1}{2}$ " roof rectangle as shown. Sew, trim, and press. Repeat using the marked $3\frac{1}{2}$ " background square. Make 1.

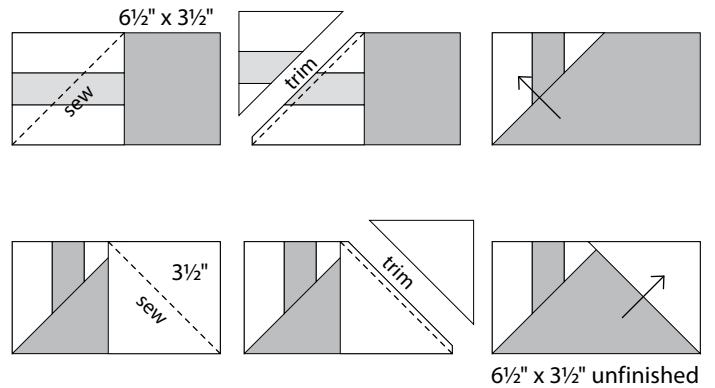

3 Assemble the house top row as shown.

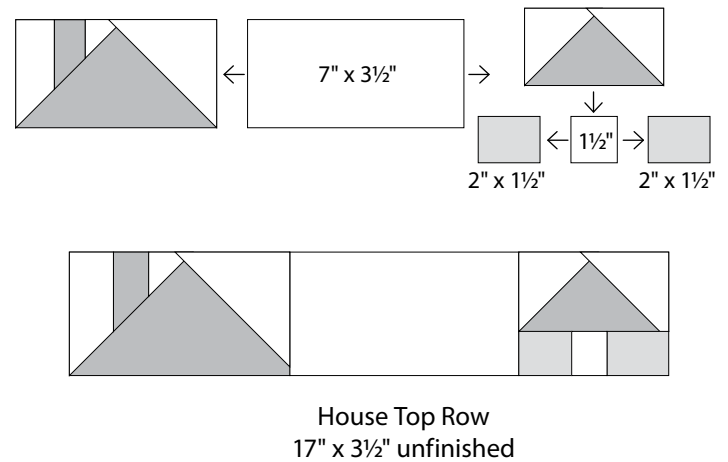

moda

4 Draw a diagonal line from corner to corner on the wrong side of a 3" background square as shown. Layer the marked square, right sides together, on a 8½" x 4½" roof rectangle as shown. Sew, trim, and press. Add the bottom of the cross as shown.

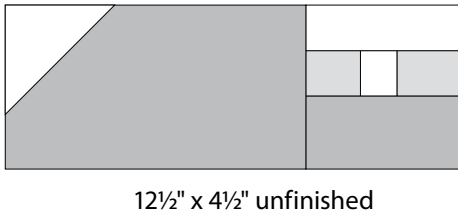
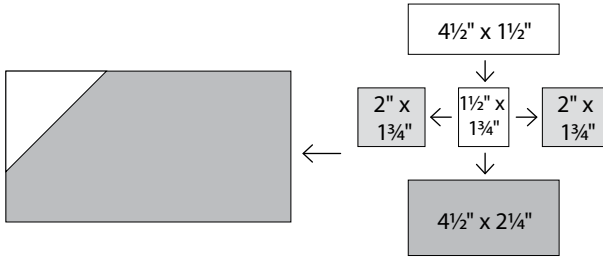
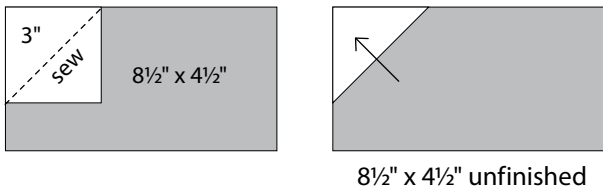

6 Assemble the block as shown.

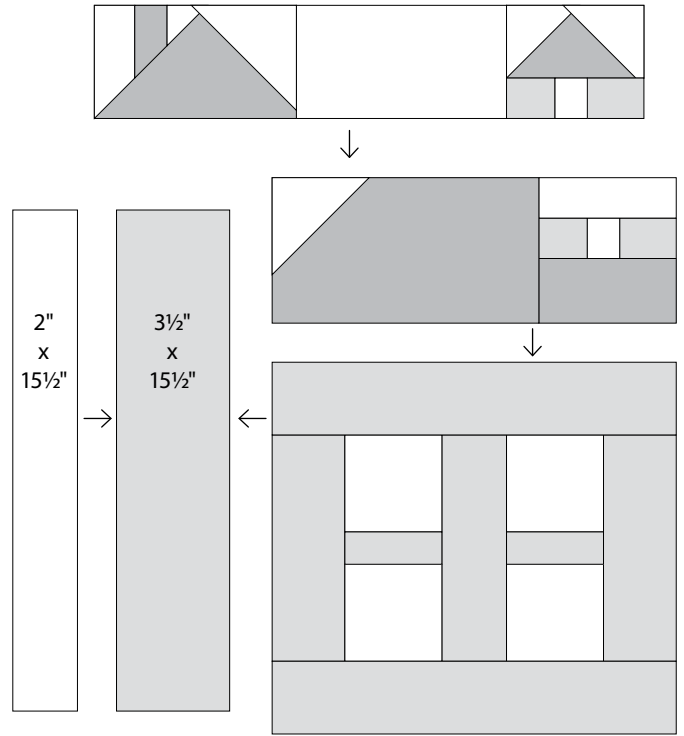

moda

5 Assemble the house windows as shown.

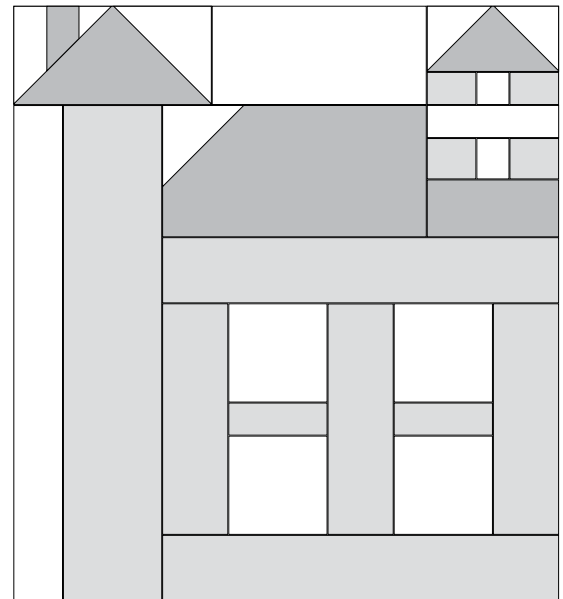
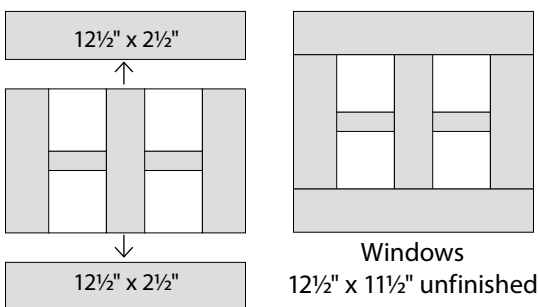
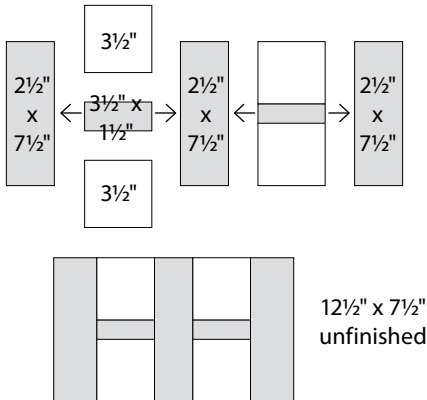

Block 16
17" x 18½" unfinished